



LOBTEX CO.,LTD.

OSAKA, JAPAN
12-8 Shijo-cho, Higashi-osaka City, Osaka 579-8053 Japan
Phone: +81 72 981 7466 Fax: +81 72 981 9420
www.lobtex.co.jp

ADVANCED FASTENING SYSTEMS

LOBSTER

MADE IN
JAPAN



Kompania Narzędziowa "HERMES" Sp. z o.o.
ul. Sarni Stok 73 a, 43-300 Bielsko-Biała, Polska; tel: +48 33 821 41 90-91
e-mail: biuro@hermestools.eu www.hermestools.eu



Kompania Narzędziowa "HERMES" Sp. z o.o.
ul. Sarni Stok 73 a, 43-300 Bielsko-Biała, Polska; tel: +48 33 821 41 90-91
e-mail: biuro@hermestools.eu www.hermestools.eu

Selection Table of Proper Riveters

Model	R1A1	R1A2	R1B1	R1B2
Feature	Ultra Lightweight	Heavy Duty & Vacuum System	Cordless Electric type	Heavy Duty Cordless Electric type
Stroke	19	26	22	22
Traction Power (N)	9,000	18,500	10,500	13,000
Weight (Kg)	1.10	1.7	1.9	2.0
Shockless	☉	☉	-	-
Vacuum system	☉	☉	-	-
Riveting Capacity	2.4 (3/32")	●	●	■
	3.2 (1/8")	●	●	■
	4.0 (5/32")	●	●	●
	4.8 (3/16")	●	●	●
	6.4 (1/4")	-	●	△
Page	P.4	P.4	P.12	P.12

Selection Table of Proper Riveters

Model	AR-011MX	AR-011HX	AR-3000EV
Feature	Durable & Portable	Durable & Portable	High power & Long Stroke
Stroke	16	16.5	24
Traction Power (N)	9,000	14,000	15,200
Weight (Kg)	1.5	2.1	1.4
Shockless	☉	☉	☉
Vacuum system	-	-	☉
Riveting Capacity	2.4 (3/32")	●	●
	3.2 (1/8")	●	●
	4.0 (5/32")	●	●
	4.8 (3/16")	●	●
	6.4 (1/4")	-	●
Page	P.7	P.7	P.7

Model	AR-2000S	AR-2000M	AR-2000H	AR-2000SV	AR-2000MV	AR-2000HV	AR-2000A-90	AR-2000A-45	AR-2000A-00
Feature	Lightweight	Higher productivity	Heavy Duty & High power	Vacuum System & Lightweight	Vacuum System & Higher productivity	Heavy Duty, Vacuum System & High power	Angle type for riveting in narrow space	Angle type for riveting in wrong position	Angle type for riveting in corner
Stroke	14	16	18.5	14	16	18.5	16	16	16
Traction Power (N)	4,800	9,100	14,000	4,800	9,100	14,000	8,000	8,000	8,000
Weight (Kg)	1.1	1.2	1.6	1.2	1.4	1.8	1.8	1.9	1.8
Shockless	☉	☉	☉	☉	☉	☉	☉	☉	☉
Vacuum system	-	-	-	☉	☉	☉	-	-	-
Riveting Capacity	2.4 (3/32")	●	■	●	●	●	●	●	●
	3.2 (1/8")	●	●	■	●	■	●	●	●
	4.0 (5/32")	△	●	■	△	●	●	●	●
	4.8 (3/16")	-	●	●	●	●	△	△	△
	6.4 (1/4")	-	●	●	-	●	-	-	-
Page	P.6	P.6	P.6	P.6	P.6	P.6	P.8	P.8	P.8

Model	ARV-025M	ARV-015MX	ARF800P	ARF-700	@R03i
Feature	Separate type & Vacuum System	In-line type & Vacuum System	Automatic Rivet Feeding System	Automatic Rivet Feeding System	Attachment Riveter
Stroke	19	16	-	-	-
Traction Power (N)	9,800	8,000	-	-	-
Weight (Kg)	0.9(Head only)	1.8	10.9	32	0.45
Shockless	☉	☉	-	-	-
Vacuum system	☉	☉	☉	☉	-
Riveting Capacity	2.4 (3/32")	●	●	-	●
	3.2 (1/8")	●	●	●	●
	4.0 (5/32")	●	●	●	●
	4.8 (3/16")	●	●	-	●
	6.4 (1/4")	-	-	-	-
Page	P.9	P.9	P.10	P.11	P.14

Model	HR-200	HR-002A	HR-002D	HR-005A	HR-003A	HR-003B	HR-2050H
Weight (Kg)	0.39	0.54	0.5	0.75	1.8	2.0	1.75
Riveting Capacity	2.4 (3/32")	●	●	●	●	●	■
	3.2 (1/8")	●	●	●	●	●	■
	4.0 (5/32")	△	●	●	△	●	■
	4.8 (3/16")	-	▲	▲	▲	●	●
	6.4 (1/4")	-	-	-	-	●	●
Page	P.14	P.14	P.14	P.14	P.15	P.15	P.15

Model	N1A2	EN-410	HND-005	HN-010	@N10d
Weight (Kg)	2.1	2.5	0.6	1.8	0.43
M3	■	■	●		
M4	●	●	●		△
M5	●	●	△	●	△
M6	●	●	▲	●	△
M8	●	●		●	
M10	●	●		●	
M12	■				
Page	P.32	P.33	P.33	P.33	P.33

△: Can not be used with stainless steel rivet. ■: Can be used if optional parts (sold separately) are attached.
▲: Can not be used with steel and stainless steel rivet.

△: Can not be used with stainless steel rivet. ■: Can be used if optional parts (sold separately) are attached.
▲: Can not be used with steel and stainless steel rivet.



Pneumatic Riveters

R1A1	4
R1A2	4
AR-2000S•2000SV	6
AR-2000M•2000MV	6
AR-2000H•2000HV	6
AR-011MX.....	7
AR-011HX.....	7
AR-3000EV	7
AR-2000A-90•AR-2000A-45• AR-2000A-00	8
ARV-015MX.....	9
ARV-025M	9

Automatic Rivet Feeding System

ARF-800P.....	10
ARF-700	11

Cordless Riveters

R1B1	12
R1B2	12

Attachment Riveter

@R03i	14
-------------	----

Hand Riveters

HR-200	14
HR-002A	14
HR-005A	14
HR-002D	14
HR-003A	15
HR-003B	15
HR-2050H.....	15

Vacuum Unit

VU-S•VU-M•VU-H48• VU-H64	15
-----------------------------------	----

Riveters

Pneumatic Riveters

High-performance R1 Series

- ▶ **R1A1** Advanced top-class Standards.
- ▶ **R1A2** A heavy duty riveter capable of setting structural rivets.

1 Narrow Frame Head

R1A1 21mm (.827") **R1A2** 22mm (.866")
22.0mm(.866") diameter Frame Head allows for use in tight spaces.

2 Long Stroke

R1A1 19mm (.748") **R1A2** 26mm (1.02")

4 The resin grip which makes it easy to grip

Well balanced tool with a comfortable feel in the operator's hand. Handle has a natural curve that is easy to grip.

5 Lightweight, durable design

A superb center-balance design is comfortable in the operators hand, enhancing the lightweight feel.

9 Comes equipped with Mandrel shutter



When the Tank case is taken off, Mandrel shutter will be closed to prevent the pop out of the spent mandrels.

3 On-board vacuum on/off switch

Simply push the button to activate vacuum, then switch to off when not in use to reduce air consumption and cost.

8 Oversized mandrel container

Oversized mandrel container. Improved efficiency = greater productivity

6 Air intake with changeable left/right direction

Air inlets on both the left and right side allowing for greater flexibility, and operator productivity

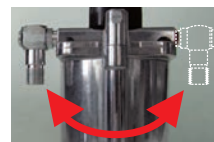

7 Reduced air consumption of approx. 30% compared with our conventional model



With an improved air circuitry design, consumes 30% less air than previous generation tools. This reduces compressor costs and is environmentally friendly



Soft-Set (Shock-less function) will decrease the impact of riveting.

Pneumatic Riveters

High-performance R1 Series

R1A1

Riveting Capacity	2.4 3/32"	3.2 1/8"	4.0 5/32"	4.8 3/16"
-------------------	--------------	-------------	--------------	--------------

- ▶ Lightweight with excellent strength-to-weight ratio
- ▶ Built-in vacuum mandrel collection system
- ▶ Compact size with extra long stroke.
- ▶ R1A1 achieves up to a 30% reduction in air consumption* which can reduce costs.



R1A2

Riveting Capacity	4.8 3/16"	6.4 1/4"
-------------------	--------------	-------------

- ▶ Heavy duty version of R1A1 yet still light weight with excellent strength-to-weight ratio
- ▶ Capable of setting standard and structural rivets
- ▶ Extra long stroke
- ▶ High Capacity mandrel collection tank

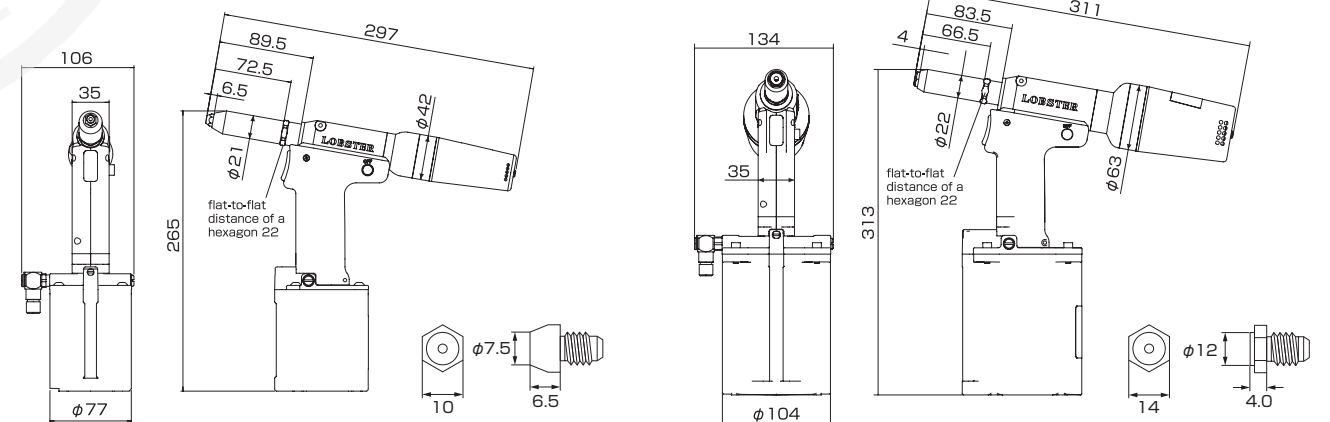

*Can be used if optional parts (sold separately) are attached. (P.15, Table. 2)

Model	Riveting Capacity φmm (inch)	Traction Power N	Stroke mm	Working Air Pressure MPa	Air Consumption	Weight kg	Operating noise dB	Jaws
R1A1	All materials 2.4 / 3.2 / 4.0 / 4.8 (3/32", 1/8", 5/32", 3/16")	9,000	19	0.5~0.6	68 (Vacuum on)	1.1	69.5	Ultra Jaw 'M'
R1A2	All materials 4.8 / 6.4 (3/16", 1/4")	18,500	26	0.5~0.6	75 (Vacuum on)	1.7	80	Ultra Jaw 'H'

*Air pressure at 0.6 Mpa



For all Riveters

• Be sure to read the instruction manual carefully and make sure that you understand them thoroughly before using the riveter.

Pneumatic Riveters

AR-2000·2000_V Series

- ▶ Lightweight riveters with resin polymer case.
- ▶ Shockless technology offers ergonomically correct action to minimize risk to CTDs (cumulative trauma disorders).
- ▶ The combination of a spring return and air return increases return speed by 30%.
- ▶ A built-in muffler reduces work noise and is gentler on the surrounding environment.
- ▶ The AR-2000V series with integrated vacuum system is low energy type riveter with simple vacuum ON/OFF switch.

AR-2000S·2000SV

Riveting Capacity	2.4 3/32"	3.2 1/8"	4.0 5/32"	4.8 3/16"
-------------------	--------------	-------------	--------------	--------------

The AR-2000S/AR2000SV are lightweight and high volume riveters for use with small diameter blind rivets.
Sets sizes ϕ 2.4, ϕ 3.2 (3/32", 1/8") and ϕ 4.0, (5/32")

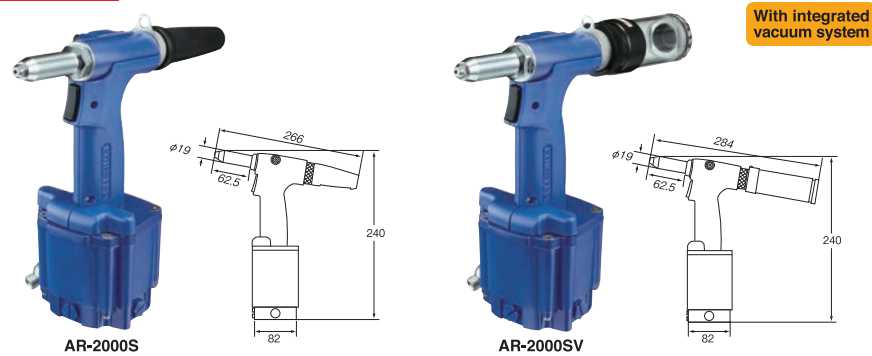

AR-2000M·2000MV

Riveting Capacity	2.4 3/32"	3.2 1/8"	4.0 5/32"	4.8 3/16"
-------------------	--------------	-------------	--------------	--------------

The AR-2000M/AR-2000MV riveters are lightweight and high volume riveters for use with blind rivets from ϕ 2.4 up to ϕ 4.8. (3/32"-3/16"). Longer stroke than previous generations of tools (AR-011M/AR-021M) resulting in improved productivity

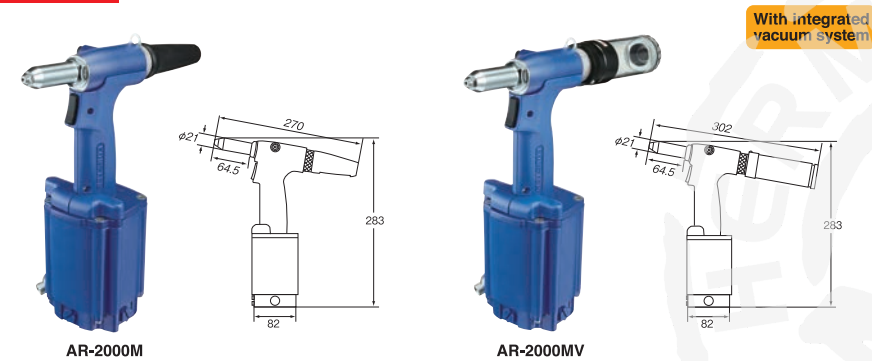

AR-2000H·2000HV

Riveting Capacity	4.8 3/16"	6.4 1/4"	S-bolt tool
-------------------	--------------	-------------	-------------

The AR-2000H/AR2000HV riveters are excellent for large diameter standard rivet sizes ϕ 4.8 (3/16") and ϕ 6.4 (1/4"). Heavy duty tools with a long stroke and are faster than previous generations of tools (AR-011H/AR-21H) Can be used with S-Bolts. (S-bolt nosepiece is sold separately.)



Model	Riveting Capacity ϕ mm (inch)					Traction Power N	Stroke mm	Working Air Pressure MPa	Air Consumption	Weight kg	Jaws
	2.4 (3/32")	3.2 (1/8")	4.0 (5/32")	4.8 (3/16")	6.4 (1/4")						
AR-2000S	○	○	△	—	—	4,800	14.0	0.5~0.6	0.6 L/rivet	1.1	S
AR-2000M	○	○	○	○	—	9,100	16.0		1.7	1.2	Ultra Jaw 'M'
AR-2000H	□	□	□	○	○	14,000	18.5		3.6	1.6	Ultra Jaw 'H'

*△ Cannot be used with stainless steel rivets. □ Can be used if optional parts (sold separately) are attached. (Page 15, Table. 1)

With integrated vacuum system

Model	Riveting Capacity ϕ mm (inch)					Traction Power N	Stroke mm	Working Air Pressure MPa	Air Consumption	Weight kg	Jaws
	2.4 (3/32")	3.2 (1/8")	4.0 (5/32")	4.8 (3/16")	6.4 (1/4")						
AR-2000SV	○	○	△	—	—	4,800	14.0	0.5~0.6	90 L/min	1.2	S
AR-2000MV	○	○	○	○	—	9,100	16.0		90	1.4	Ultra Jaw 'M'
AR-2000HV	—	□	□	○	○	14,000	18.5		120	1.8	Ultra Jaw 'H'

*△ Cannot be used with stainless steel rivets. □ Can be used if optional parts (sold separately) are attached. (Page 15, Table. 1)

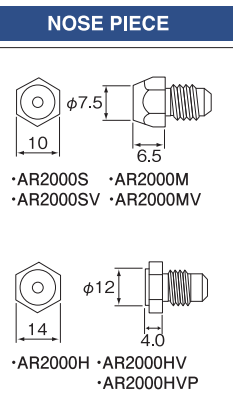

Pneumatic Riveters

Basic types

- ▶ Launched in 1967 and following a long line of success in the field, features redesigned improvements.

AR-011MX

Riveting Capacity	2.4 3/32"	3.2 1/8"	4.0 5/32"	4.8 3/16"
-------------------	--------------	-------------	--------------	--------------

- Durable! A main feature of the AR-011 is its durability.
- Increase in stroke! The MX series will increase from 14mm (0.55") to 16mm (0.63") in stroke length.(14%up!)
- Capable of pulling Stainless rivets! With the Ultra Jaws and Soft-Set function, will allow the MX/HX series to set Stainless rivets.
- Improves maintenance...Applying one-touch detachable Jaw Case, its maintenance has become easier.
- Lower noise level. The standard silencer function will improve overall working environment.
- Improved operating performance. The new Rotary Joint and soft safety cover will improve usage by the operator.
- Customization. Optional parts will expand capabilities and operator usage.

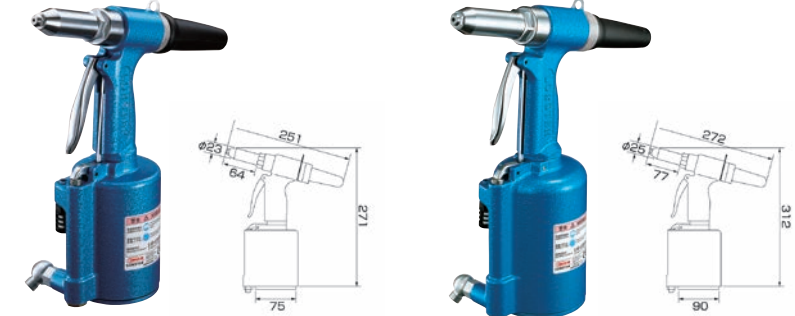

AR-011HX

Riveting Capacity	2.4 3/32"	3.2 1/8"	4.0 5/32"	4.8 3/16"	6.4 1/4"
-------------------	--------------	-------------	--------------	--------------	-------------

AR-3000EV

Riveting Capacity	4.8 3/16"	6.4 1/4"	S-bolt tool
-------------------	--------------	-------------	-------------

Increases work efficiency through its lightweight and highly-refined riveting speed. Its high power and long stroke makes this model appropriate for S-bolt and long type rivets. 4.8 (3/16") and 6.4 (1/4") blind rivets can be used if optional parts (sold separately) are attached.

- Note: ϕ 4.8 and ϕ 6.4 standard rivets can be used if optional parts are attached(sold separately).

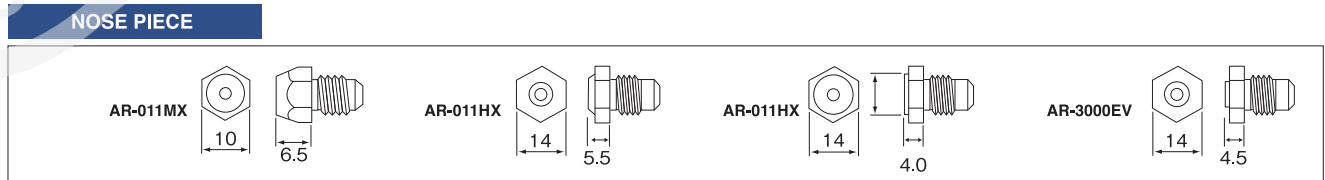
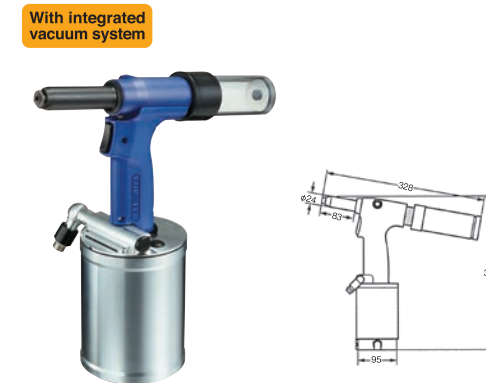

Model	Riveting Capacity ϕ mm (inch)					Traction Power N	Stroke mm	Working Air Pressure MPa	Air Consumption	Weight kg	Jaws
	2.4 (3/32")	3.2 (1/8")	4.0 (5/32")	4.8 (3/16")	6.4 (1/4")						
AR-011MX	○	○	○	○	—	9,000	16.0	0.5~0.6	1.5	1.5	Ultra Jaw 'H'
AR-011HX	○	○	○	○	○	14,000	16.5		2.9	2.1	Ultra Jaw 'M','H'

*△ Cannot be used with stainless steel rivets.

With integrated vacuum system

Model	Riveting Capacity ϕ mm (inch)					Traction Power N	Stroke mm	Working Air Pressure MPa	Air Consumption	Weight kg	Jaws
	2.4 (3/32")	3.2 (1/8")	4.0 (5/32")	4.8 (3/16")	6.4 (1/4")						
AR-3000EV	—	—	—	○	○	15,200	24.0	0.5~0.6	90 L/min	1.4	Ultra Jaw 'H'

* ϕ 4.8 and ϕ 6.4 standard rivets can be used if optional parts are attached(sold separately).

Pneumatic Riveters

Angle types

- ▶ Riveting in narrow spaces
- ▶ Riveting in corners or obstructed areas
- ▶ Riveting in difficult access
- ▶ Riveting head can turn 360° which enables work with better posture and improved production efficiency.

AR-2000A-90 · AR2000A-45 · AR2000A-00

Riveting Capacity	2.4 3/32"	3.2 1/8"	4.0 5/32"	4.8 3/16"
-------------------	--------------	-------------	--------------	--------------

■ Note: Cannot be used with φ4.8 stainless steel blind rivets.

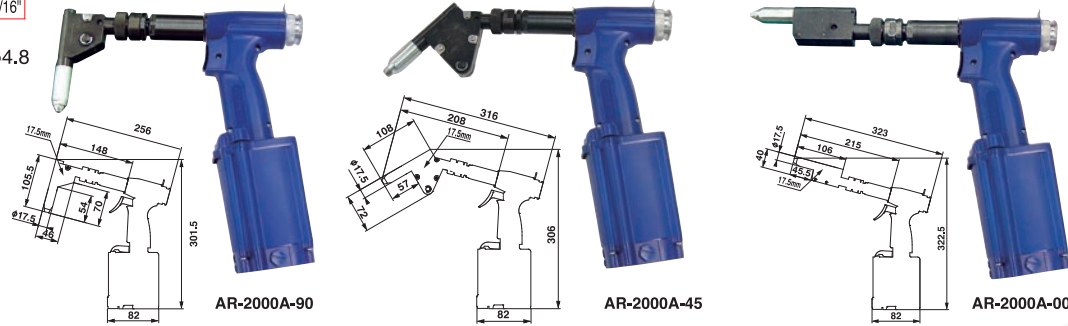

Model	Riveting Capacity φmm (inch)					Traction Power N	Stroke mm	Working Air Pressure MPa	Air Consumption	Weight kg	Jaws	NOSE PIECE	
	2.4 (3/32")	3.2 (1/8")	4.0 (5/32")	4.8 (3/16")	6.4 (1/4")							AR-2000A-90	AR-2000A-45 AR-2000A-00
AR-2000A-90	○	○	○	△	—	8,000	16.0	0.5~0.6	1.7 L/rivet	1.8	S	10	6.5
AR-2000A-45	○	○	○	△	—							1.9	
AR-2000A-00	○	○	○	△	—							1.8	

*△ Cannot be used with stainless steel rivets.

Application

Example 1 Can not riveting at the target place

Riveting point was so close to the corner, we had to alter some part of riveter or had to be compelled to miss the target

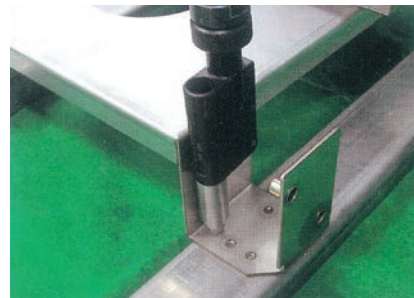
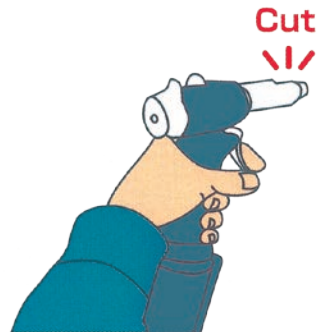

00 Offset nose of AR2000A-00 allows perfect riveting at dead set place

Example 2 Can not riveting in recess

At a place inaccessible with conventional riveters, we were compelled to do riveting improperly.



45 Angle nose of AR2000A-45 offers smooth riveting at hard-to-reach place

Example 3 Can not riveting at a narrow space

At an unusual place, welding was the only way to access the point where does not allow to approach with riveters.



90 Angle nose of AR2000A-90 allows to riveting inside of the cylinder, shown as picture

Pneumatic Riveters

In-line type

ARV-015MX

Riveting Capacity	2.4 3/32"	3.2 1/8"	4.0 5/32"	4.8 3/16"
-------------------	--------------	-------------	--------------	--------------

- Straight ejection of the spent mandrels
- Increase in stroke!
- Capable of Pulling 4.8mm(3/16")Stainless rivets!
- Maintenance has become easier.
- Rivets will not fall off downwards.

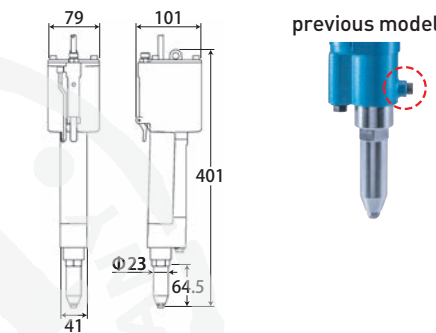

Change the position of the Chute hose and improved operating performance!!

Straight ejection of the spent mandrels

- Easier to operate by similar location with balancer and air hose.
- Decrease the clog of mandrels by making the Chute hose straight.

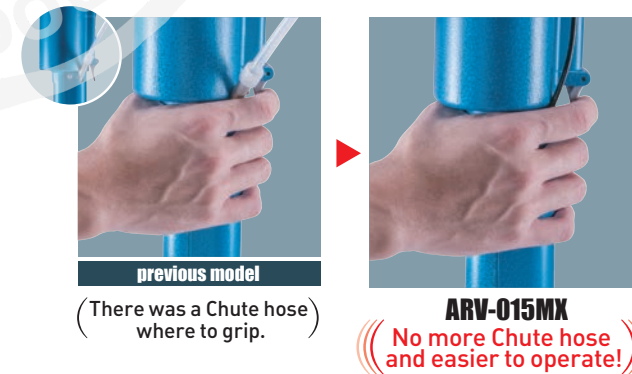

Model	Riveting Capacity φmm (inch)					Traction Power N	Stroke mm	Working Air Pressure MPa	Air Consumption	Weight kg	Jaws	NOSE PIECE	
	2.4 (3/32")	3.2 (1/8")	4.0 (5/32")	4.8 (3/16")	6.4 (1/4")							ARV015MX	ARV-025M
ARV015MX	○	○	○	○	—	8,000	16.0	0.5~0.6	100	1.8	Ultra Jaw 'M'	10	6.5
ARV-025M	○	○	○	○	—	9,800	19.0	0.5~0.6	100	0.9	Ultra Jaw 'M'		

*Head weight only

WARNING

For all Riveters

- Be sure to read the instruction manual carefully and make sure that you understand them thoroughly before using the riveter.

Pneumatic Riveters

Separate type

ARV-025M

With integrated vacuum system

Riveting Capacity	2.4 3/32"	3.2 1/8"	4.0 5/32"	4.8 3/16"
-------------------	--------------	-------------	--------------	--------------

- Soft-Set® shockless technology offers ergonomically correct action to minimize risk of CTDs (cumulative trauma disorders).
- Ultra jaws for longer jaw life
- Lightweight, compact riveting head weighs under two pounds and works with remote intensifier
- In-line vertical design for ergonomic benefits in a workstation environment
- New design features unique ergonomic trigger placement in the natural operator gripping area for improved tool control
- Exclusive hydraulic swivel fittings for ease of operator flexibility
- Built-in on demand mandrel vacuum system for mandrel retention and evacuation to an off-line receptacle
- Long stroke
- Able to operate in conjunction with our exclusive ARF-700 autofeeding rivet presenter system

Intensifier Unit: Interchangeable with all three models (ARV-025M, ARV-022M, and AR-022M). Heads are changed at the quick-disconnect hydraulic fitting.

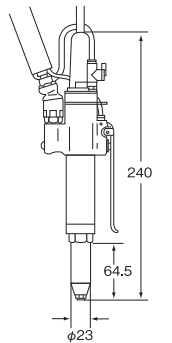

Portable Rivet Feeder

▶ Adaptable to changes in workplace and Easy to carry around Achieved greater flexibility in installation site!

ARF-800P



Dimensional drawing (unit: mm)

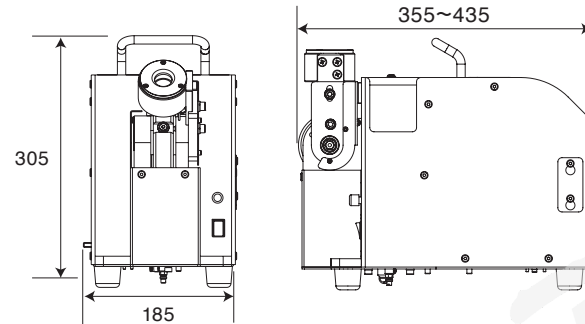

Features

Achieved greater productivity!

- High speed rivet feeding
- Able to feed 20pcs rivets per 1 minute.

■ Comparison of feeding work
 By hand **1820**minutes
ARF-800P **1340**minutes **480** minutes reduced

[Measuring condition]
 When needs to hold workpiece by one hand, compared man-hour of 1,000pcs of riveting work per day/person for 20 days.

Improving energy saving performance!

Compared to conventional model (ARF700)

Installation space **55% reduced**
 Weight **70% reduced**
 Air consumption **23% reduced**

Smaller footprint!



- Easy to set up
- Only requires A4 size of space to set up!

Portable



- Easy to carry around
- Only 10.9kg (24lb) in weight

Adjustable to best position

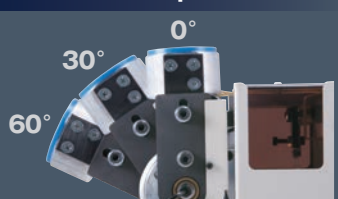

Adjustable in 3 angles

Large capacity of basket

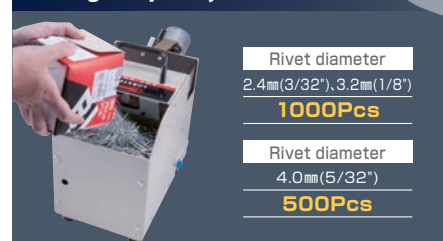

Rivet diameter 2.4mm (3/32"), 3.2mm (1/8")
1000Pcs
 Rivet diameter 4.0mm (5/32")
500Pcs

Specification

Weight	10.9kg (24lb)
Electric power source	AC 100~240V (50~60Hz)
Operating voltage	DC 12V
Consumption current	<1A
Operating air pressure	0.5~0.6MPa
Air consumption	Per 1 rivet 3.1 ℓ /Pcs
	When using 20 rivets per 1 minute 62 ℓ /Minutes
Applicable rivet size	2.4mm (3/32"), 3.2mm (1/8"), 4.0mm (5/32")
Operation environments	Ambient temperature 5~40°C
	Humidity less 80%RH (No bedewing)
Range of storage temperature	-5~55°C
Noise emission	<75dB
Diameter of air supply	φ6mm (One touch air joint) ※1

※1 Prepare the air connector and tube of φ6mm

Type of ARF800P

Compatible rivets	Diameter of frame head holder	Riveters	
		ARF800P	
-24	-A (19mm)	AR-2000SV	
-32			
-40			
-24	-B (21mm)	R1A1※2 AR-2000MV	
-32			
-40			
-24	-C (23mm)	ARV-011MX ARV-015MX ARV-025M	
-32			
-40			

※2. When using old frame head which diameter is 22mm, it needs to be changed to new frame head (21mm).
 Ex: When using AR-2000MV and need rivet feeder for 3.2mm (1/8") rivets, purchase by part number ARF800P-32B (21mm).

ARF-700 Outline and Performance

Faster, reliable, improved work efficiency!

Outline

- Reduces riveting cycle time and lowers running costs.
- Reduces the time lost when inserting rivets into the riveter.
- Rivet loading is half-automated so it is possible to simultaneously line up the holes in the material during loading.

Performance

- Approx. 60 rivets/minute loading speed
- Riveting speed of over 1,500 rivets/hour possible

ARF-700

<Sold separately> Compatible air riveters

- ARV-015M, ARV-022M, ARV-025M, AR-2000SV, AR-2000MV, and ARV-011M, R1A1
- With VU-M vacuum unit: AR-011M
- With optional frame head: ARV-015M
- With optional frame head and VU-S vacuum unit: AR-011S

<Note>

- Large flange blind rivets cannot be used with the ARF-700.



Rivets aligned and sent to the feeder head (with cover open)



ARF-700 Functions and Features

Improved productivity and workability

- Each rivet is automatically held in place as soon as the riveter is inserted into the feeder head.
- One hand is free allowing for material handling or other workstation tasks.
- Productivity is increased by 180% to 300% (Estimation by Lobtex)
- Clean work environment can be maintained using the detachable mandrel vacuum system hose (option).

Freely adjustable line layout

- Feeder casters allow for portability simple.
- Compact design eliminates the need to designate specific installation location.
- Easily detachable feeder head can be set in the appropriate location along the line.
- Feeder head is expandable (option) to fit the size of the rivet.

Durable, maintenance-free design

- Misfeed tank helps avoid delays by catching misfed rivets and allowing system to continue to operate.
- Acrylic lid on top of the feeder allow easy replenishment of rivets.
- Set the rivets on the track rail and operation will pause to save energy.
- Counter (option) displays the number of rivets used for easy verification.

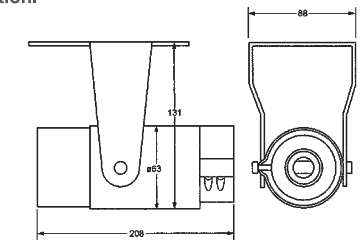

Process comparison of riveting cycle (between our conventional method and the ARF-700 method)

Conventional method

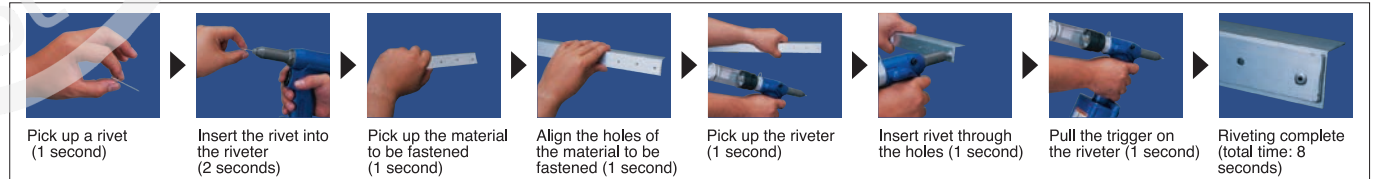

ARF method

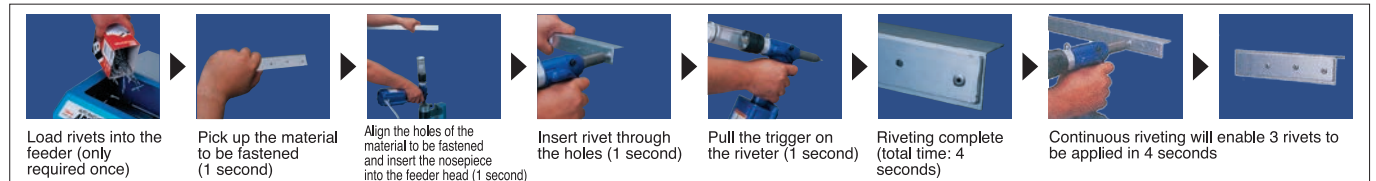

Specifications

ARF-700 Feeder	
External dimensions (W×H×D)	447 mm×364 mm×528 mm
Weight	32 kg (total: 36 kg)
Working air pressure	0.5 MPa to 0.6 MPa
Power	AC 120, 230 V, 50/60 Hz
Power consumption	70 W

*AC220V, 50/60Hz optional

*AC120V, 60Hz optional

Auto Rivet Feeder	Capacity (rivets)	Compatible rivet sizes (diameter)
ARF-700-32	2,000	3.2 (1/8")
ARF-700-40	1,500	4.0 (5/32")
ARF-700-48	1,000	4.8 (3/16")

(Unit: mm)

WARNING

For all Riveters

• Be sure to read the instruction manual carefully and make sure that you understand them thoroughly before using the riveter.

Cordless Riveters

R1B1

Riveting Capacity	2.4	3.2	4.0	4.8
	3/32"	1/8"	5/32"	3/16"



Compact, fast, and easier to use.
Advanced Cordless Riveter

A high-performance yet compact cordless riveter has made its debut, going beyond the conventional norm. This tool substantially improves work efficiency and precisely meets your needs when long hours of work are required.

It is a Lobtex masterpiece, with energy-saving and foolproof features, and it helps fulfill your desire to make your factory "cordless."

The smallest size and compact body in its class.



R1B2

Riveting Capacity	4.8	6.4
	3/16"	1/4"



A high-power model in correspondence with high-strength blind rivets!

※6.4mm stainless steel rivet cannot be used.
3.2 and 4.0mm rivets can be used if optional parts are attached.

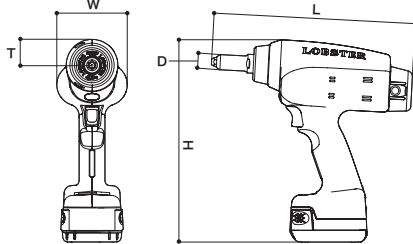

Cordless Riveters

Energy-saving and environmentally friendly

Installs seven times more rivets than conventional models on a single charge. The R1B1 and R1B2 consumes only one forty-fifth of the power consumed by an air riveter thanks to a lithium-ion battery and energy-efficient power transmission system. (※1) This riveting tool installs 560 rivets on a single charge. (※2)

The smallest size and compact body in its class

Lobtex's unique motor layout provides for a more compact body with a shorter distance between trigger and riveting point which ensures ease of rivet setting and riveting process.

Functionality and aesthetic design

Designed by Product Designer Toshiyuki Kita, the R1B1 and R1B2 is easy to grip, well balanced and aesthetically functional yet, built to endure the everyday work environment.

Energy-efficient power transmission system

A ball screw that efficiently converts rotations to linear motions and a planetary gear that transmits greater torque to ensure smoother riveting.

High Speed Riveting

With a 1.5 second cycle time, ranks the R1B1 and R1B2 in the industry's fastest class of cordless riveters. Substantially faster than previous models, the R1B1 and R1B2 truly converts your factory "cordless". (※1)

Handling user-friendly

The cordless design gives exceptional ease of operation. The handle is installed at an angle for positioning the tool toward the riveting point with ease. In addition, the tool's excellent weight balance causes less wrist fatigue after long hours of work. The grip-assist elastomer ensures reliable non-slippery grip for use with gloves.

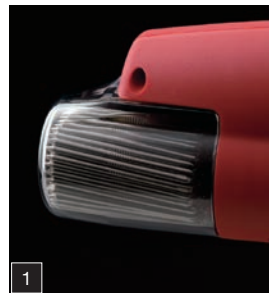

1 Mandrel Collector

Mandrel collector with increased capacity for improved work efficiency

The mandrel collector placed on the side allows for location of mandrel ejection port on the top of the tool. This design is effective for smoothly storing mandrels throughout the collector, resulting in an increased number of mandrels stored during work. Minimal work interruptions make riveting less frustrating.



2 LED Spotlight

LED spotlight for precisely illuminating the object

Feel assured even when working in a dimly lit or narrow place. An LED spotlight illuminates the riveting area precisely.

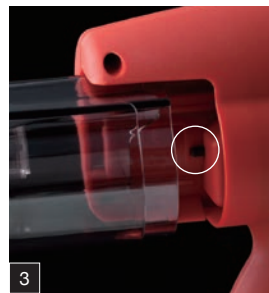

3 Safety Device

Safety device to prevent mandrels from shooting out

In a case where the mandrel collector is dislodged or not fitted properly, a safety device is actuated to interrupt the riveter power supply and disable the trigger. This feature prevents mandrels from shooting out and ensures work safety.



4 Made in Japan Battery

Highly reliable Japanese-made battery

A high-capacity lithium-ion battery, made in Japan, significantly increases the amount of work done during the battery's life. The R1B1 and R1B2 installs 560 rivets on a single charge. (※1)



5 Ejection Capability

Eject rivets in the event of unexpected operation stoppage

Even if the riveting tool stops working due to battery depletion with a rivet in the process of being clamped, it is possible to remove the rivet by pressing the eject button.



6 Counter

Foolproof system well suited for riveting management

The R1B1 can be supplied with a digital counter (built to order). Unless each riveting cycle is complete, the counter does not advance, enabling the user to minimize overlooked work deficiencies or riveting defects and to achieve foolproof rivet number management.

(※1) Comparison with the compressor power consumption at the time pneumatic riveter is used.
(※2) Measurement using 4.8mm(3/16") stainless steel rivet (NST6-2).

Model	Overall Length (L)	Height (H)	Frame Head Diam. (D)	Width (W)	Weight (kg)	(T)	Stroke (mm)	Traction Power (N)	Jaws	Compatible Rivets (mm (inch))
R1B1	260	260	21.0	90	1.9	33	22	10,500	Ultra Jaw 'M'	2.4 / 3.2 / 4.0 / 4.8 (3/32", 1/8", 5/32", 3/16")
R1B2	268	260	23.0	90	2.0	33	22	13,000	Ultra Jaw 'H'	4.8 / 6.4 (3.2 / 4.0) (3/16", 1/4" (1/8", 5/32")) ※

※At the time battery pack BPL1415 is installed. ※3.2 / 4.0mm(1/8", 5/32") rivets can be used if optional parts are attached. ※6.4mm stainless steel rivets cannot be used.

Battery Pack Specifications

Model	Type	Voltage Rating	Capacity	Charging Time (□)		Code No.
				Full Charge	Charge for Practical Use	
BPL1415	Li-ion	14.4 V DC	1.5 Ah	60 min	45 min	8860
BPL14	Li-ion	14.4 V DC	3.0 Ah	120 min	90 min	8856

※Full charge: 0% → 100% Charge for practical use: 0% → 80%

Charger Specifications

Model	Power	Code No.
BC0075G	100-240 V AC	(230V) 8900 (120V) 8896

Nosepiece



Attachment Riveter

- ▶ Instantly turn your impact driver into riveter!
- ▶ Compatible with standard hexagonal chucks, so attachment to electric tools is simple.
- ▶ For automotive repair! For Do-it-Yourself projects! For home repairs!

@R03i

Riveting Capacity	2.4	3.2	4.0	4.8
	3/32"	1/8"	5/32"	3/16"

Powerful riveting in a single operation from one side of the work! Easy even for women without a strong grip! Unlike manual riveters, there is no hand pain or fatigue even during large volume riveting, thus increasing the possible scope of work!

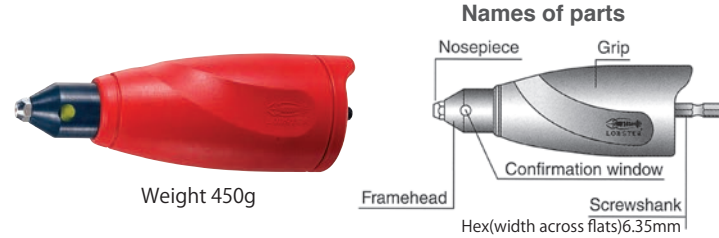

Weight 450g



Model	Riveting Capacity ϕ mm (inch)				Weight kg	Jaws
@R03i	2.4 (3/32")	3.2 (1/8")	4.0 (5/32")	4.8 (3/16")	0.45	M

Hand Riveters

HR-200

Riveting Capacity	2.4	3.2	4.0
	3/32"	1/8"	5/32"

Floating Jawcase Mechanism

- For professional and home use
- Built-in damper reduces weight of shock
- Sets rivets up to 4.0 mm (5/32")



HR-002A

Riveting Capacity	2.4	3.2	4.0	4.8
	3/32"	1/8"	5/32"	3/16"

General Duty Hand Riveters

- Aluminum diecast frame and drop-forged steel lever handle
- Wide self-opening spring for easy re-gripping
- Automatic mandrel ejection
- Comes with four nosepieces to set rivets up to 4.8 mm (3/16")



HR-005A

Riveting Capacity	2.4	3.2	4.0	4.8
	3/32"	1/8"	5/32"	3/16"

Flexible Hand Riveters

- Versatile design for 360° multi-directional riveting
- Quick change nose head direction
- Comes with four nosepieces to set rivets up to 4.8 mm (3/16")



HR-002D

Riveting Capacity	2.4	3.2	4.0	4.8
	3/32"	1/8"	5/32"	3/16"

Floating Jawcase Mechanism

- Overcomes drawbacks of conventional hand riveters by holding the rivet firmly regardless of tool position.
- Special palm and hand grip for ease and comfort
- Comes with four nosepieces to set rivets up to 4.8mm (3/16")

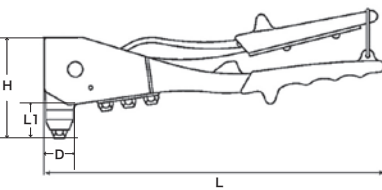

Model	Riveting Capacity ϕ mm (inch)					Weight kg	L mm	L1 mm	H mm	D mm	Jaws
	2.4 (3/32")	3.2 (1/8")	4.0 (5/32")	4.8 (3/16")	6.4 (1/4")						
HR-200	○	○	△	—	—	0.39	200	40	85	ϕ 19	S
HR-002A	○	○	○	▲	—	0.54	265	32	79	ϕ 20	S
HR-002D	○	○	○	▲	—	0.5	270	20	83	ϕ 20	S
HR-005A	○	○	△	▲	—	0.75	300	30	83	ϕ 22	S

△ Cannot be used with stainless steel rivets.
▲ Cannot be used with steel and stainless steel rivet.

Heavy Duty Hand Riveters

- Longer handles and gear mechanism exert greater rivet break power
- Maintenance-free simple rugged construction
- Sets rivets up to 6.4 mm (1/4") stainless steel as well as T-Rivet® and Monobolt®.

HR-003A

Riveting Capacity	4.0	4.8
	5/32"	3/16"



HR-003B

Riveting Capacity	4.8	6.4
	3/16"	1/4"

Can be used if optional parts (sold separately) are attached. (P.36, Table. 2)



HR-2050H

Riveting Capacity	4.8	6.4
	3/16"	1/4"

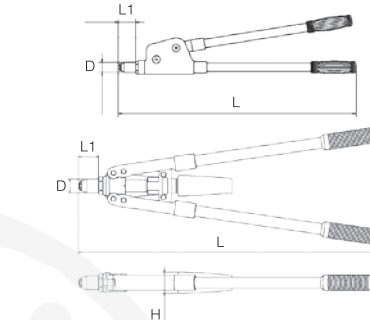

Model	Riveting Capacity ϕ mm (inch)					Weight kg	L mm	L1 mm	H mm	D mm	Jaws
	2.4 (3/32")	3.2 (1/8")	4.0 (5/32")	4.8 (3/16")	6.4 (1/4")						
HR-003A	—	—	○	○	—	1.8	610	43	—	25	M
HR-003B	—	—	—	○	○	2.0	760	41	—	25	H
HR-2005H	□	□	□	○	○	1.75	532	33	37	24	H

□ Can be used if optional parts (sold separately) are attached.

VU-S · VU-M · VU-H48 · VU-H64



Specifications

Model	Riveting Capacity ϕ mm (inch)					Compatible models	Working Air Pressure MPa	Air Consumption	Weight g	Recommended chute hose* (option)
	2.4 (3/32")	3.2 (1/8")	4.0 (5/32")	4.8 (3/16")	6.4 (1/4")					
VU-S	○	○	—	—	—	AR-011S	0.5~0.6	About 100 L/min	280	Material: nylon Internal diameter: 5.9 mm x Length: 1,900 mm
VU-M	—	○	○	○	—	AR-011M·AR-021M				
VU-H48	—	—	—	○	—	AR-011H·AR-021H				
VU-H64	—	—	—	—	○					

*By connecting directly to a nozzle unit that can be disconnected from the tank, detached mandrels can be expelled into a designated location.

Optional Parts

Table 1. Riveters

Description	AR-2000H	AR-2000HV	HR-2050H
	Code No.	Code No.	Code No.
Jaws case head M	14378	14378	20528
Jaws M	—	—	10117
Ultra jaws M	10281	10281	—
Jaws pusher H	10224	10224	—
Nosepiece L 2.4	10213	—	10213
Nosepiece L 3.2	10214	10214	10214
Nosepiece L 4.0	10215	10215	10215

Table 2. S-bolts Tools

Description	Code No.
Nosepiece 4.8 for S-bolts	43751
Nosepiece 6.4 for S-bolts	43750

WARNING

For all Riveters

- Be sure to read the instruction manual carefully and make sure that you understand them thoroughly before using the riveter.

Lobster tools Specification of Pneumatic Riveter

Type	Part Number	Vacuum	Rivet Diameter					S-Bolt	Jaws	Soft Set (Shock-less)	Stroke	Air Consumption (Air Pressure 0.6MPa)	Traction Power	Frame Head Diameter	Weight	Working Air Pressure
			2.4mm 3/32"	3.2mm 1/8"	4.0mm 5/32"	4.8mm 3/16"	6.4mm 1/4"									
Ultra Light Type	R1A1	○	○	○	○	○	-	-	Ultra Jaw 'M'	○	19mm .748"	68L/min*	9.0kN	21φmm .827"	1.1kg 2.43lb	0.5 -0.6 MPa
	R1A2	○	-	-	-	○	○	★	Ultra Jaw 'H'	○	26mm 1.024"	75L/min*	18.5kN	22φmm .866"	1.7kg 3.75lb	
Light Type	AR2000S	-	○	○	△	-	-	-	S	○	14mm .551"	(0.6L/pcs)	4.8kN	19φmm .748"	1.1kg 2.43lb	
	AR2000M	-	○	○	○	○	-	-	Ultra Jaw 'M'	○	16mm .630"	(1.7L/pcs)	9.1kN	21φmm .827"	1.2kg 2.65lb	
	AR2000H	-	□	□	□	○	○	★	Ultra Jaw 'H'	○	18.5mm .728"	(3.6L/pcs)	14.0kN	24φmm .945"	1.6kg 3.53lb	
	AR2000SV	○	○	○	△	-	-	-	S	○	14mm .551"	90L/min	4.8kN	19φmm .748"	1.2kg 2.65lb	
	AR2000MV	○	○	○	○	○	-	-	Ultra Jaw 'M'	○	16mm .630"	90L/min	9.1kN	21φmm .827"	1.4kg 3.09lb	
	AR2000HV	○	-	□	□	○	○	★	Ultra Jaw 'H'	○	18.5mm .728"	120L/min	14.0kN	24φmm .945"	1.8kg 3.97lb	
Standard Type	AR011MX	-	○	○	○	○	-	-	Ultra Jaw 'M'	○	16mm .630"	(1.8L/pcs)	9.0kN	23φmm .906"	1.5kg 3.31lb	
	AR011HX	-	○	○	○	○	○	-	Ultra Jaw 'M', 'H'	○	16.5mm .650"	(2.4L/pcs)	14.0kN	25φmm .984"	2.1kg 4.63lb	
In-Line Type	ARV015MX	○	○	○	○	○	-	-	Ultra Jaw 'M'	○	16mm .630"	100L/min	8.0kN	23φmm .906"	1.8kg 3.97lb	
Separate Type	ARV025M	○	○	○	○	○	-	-	Ultra Jaw 'M'	○	19mm .748"	100L/min	9.8kN	23φmm .906"	0.9kg 1.98lb (Head)	
Angle Type	AR2000A90	-	○	○	○	△	-	-	S	○	16mm .630"	(1.7L/pcs)	8.0kN	17.5φmm .689"	1.8kg 3.97lb	
	AR2000A45	-	○	○	○	△	-	-	S	○	16mm .630"	(1.7L/pcs)	8.0kN	17.5φmm .689"	1.9kg 4.19lb	
	AR2000A00	-	○	○	○	△	-	-	S	○	16mm .630"	(1.7L/pcs)	8.0kN	17.5φmm .689"	1.8kg 3.97lb	
Ultra Light Type (for S-Bolt)	AR3000EV	○	-	-	-	●	●	☆	Ultra Jaw 'H'	○	24mm .945"	120L/min	15.2kN	22φmm .866"	1.4kg 3.09lb	

*When air pressure is 0.6MPa △ Cannot be used with Stainless Steel rivets, □ Can be workable by using optional parts, ● When using open-type rivets optional parts will be required. ☆ Comes with optional parts for S-bolt ★ Can be used when using Optional parts(sold separately)

*Soft-Set is the name of LOBSTER shock-less function which will reduce the riveting impact.

Specification of Cordless Riveter

Type	Part Number	Type of Battery	Rivet Diameter					S-Bolt	Voltage Rating	Jaws	Stroke	Capacity	Traction Power	Frame Head Diameter	Weight
			2.4mm 3/32"	3.2mm 1/8"	4.0mm 5/32"	4.8mm 3/16"	6.4mm 1/4"								
Cordless Type	R1B1	Li-ion	○	○	○	○	-	-	DC14.4V	Ultra Jaw 'M'	22mm .866"	1.5Ah (*3.0Ah)	10.5kN	21φmm .827"	1.9kg 4.19lb
	R1B2	Li-ion	-	□	□	○	△	★		Ultra Jaw 'H'	22mm .866"	1.5Ah (*3.0Ah)	13.0kN	23φmm .906"	2.0kg 4.41lb

△ Cannot be used for 6.4mm(1/4") stainless rivets □ Can be used by optional parts(sold separately) ★ When using R1B2 to rivet S-bolt, can be used by using optional parts(sold separately) *Battery pack capacity 3.0Ah is sold separately

Blind Rivets

NSA 20

NTA 21

NA 22

NS 23

NSS 24

NST 25

NSA-K 26

Large-flange Blind Rivets

NSA-LF 26

AP Rivets

AP 27

Blind Rivets (shield type)

NSA-C 27

Colored Blind Rivets

C-NSA 28

High Performance Blind Rivets Bulb-Type Rivets

NSTB 28

High Strength Blind Rivets

S-bolt 29



Blind Rivets

LOBSTER Blind Rivet Fastening Method

What is LOBSTER blind rivet?

LOBSTER blind rivets can be used in a variety of assembly processes. Because multiple base materials can be fastened together in a single operation from one side of the work, these rivets contribute greatly to labor savings, lowered costs and increased work speed. In addition, the various head shapes and material combinations that are available with blind rivets make it possible to easily conform to various industrial design specifications. Further, by using LOBSTER blind rivets in conjunction with LOBSTER riveters and other automatic fastening systems and their prominent quality, reliability and results, the positive effect is doubled.

LOBSTER Blind Rivet Operating Method

Blind rivet work procedure

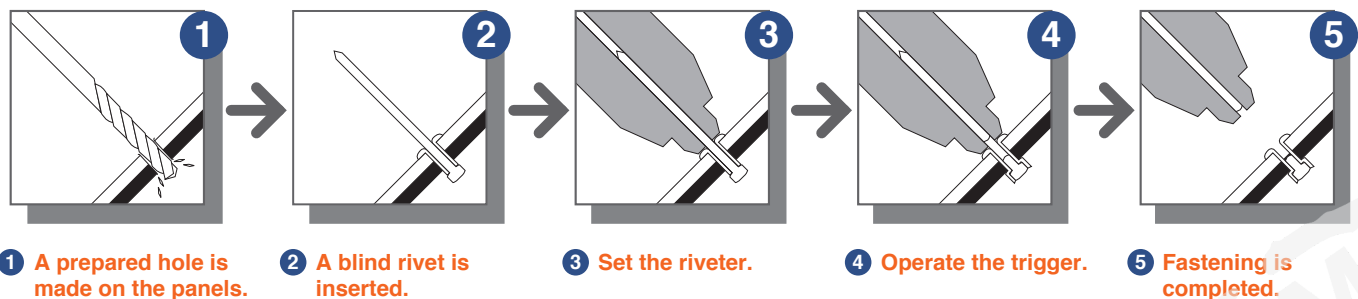

The difference between conventional methods and the LOBSTER blind rivet method

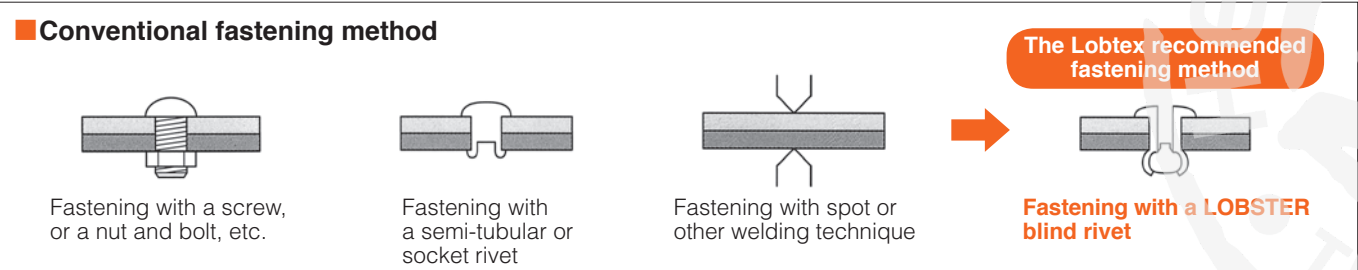

Applications

Automotive / transport



Example applications

Automotive ornamentation, automotive interior decoration, two-wheeled vehicles, refrigeration vehicles, dry vans, bus bodies, railroad cars, airplanes, forklifts, all-terrain vehicles, various containers, motorcycles, snowmobiles, etc.

Electric / Electronic equipment

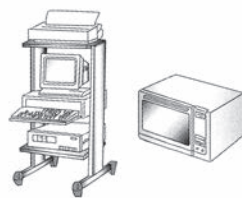

Example applications

Computer racks, cubicles, elevators, lighting, household appliances, power supply units, office equipment, terminals, substrates and circuit boards, various meters and instruments, etc.

Construction



Example applications

Gates, carports, rain lattices, fences, handrails, entrance doors, sliding storm doors, bay windows, windows shutters, storage sheds, prefab houses, curtain walls, steel-frame houses, insulation sashes, construction hardware, etc.

In addition to the above example applications, LOBSTER blind rivets can be applied to any of a variety of different assemblies. Contact our company representative or technical support if you have any technical questions.

Structure of Blind Rivet

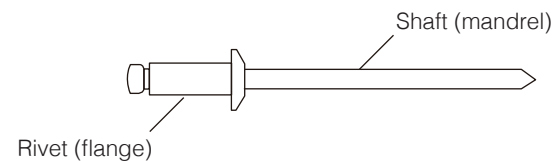

LOBSTER Blind Rivet P/N Explanation

Example P/N
NSA62
 Rivet diameter (ϕ 4.8mm)
 $6 \div 32 \times 25.4 \approx \phi$ 4.8mm
 Maximum grip length (ϕ 3.2mm)
 $2 \div 16 \times 25.4 \approx \phi$ 3.2mm
 Rivet material (aluminum)
 Shaft material (steel)
 The original Japanese name of Lobstex ("N" for Nippon Riki)

Selection Table of Proper Rivets

Domed head	NSA/NTA/NA/NS/NSS/NST/NSC/NCC	The standard type of rivet. Available in a variety of sizes and materials.	Shield	NSA-C/NST-C (Production upon order)	Closed rivet head for superior waterproof characteristics.
Countersunk (flush) head	NSA-K	These rivets are used when it is desirable to maintain a flat surface.	Bulb type	NSTB	Excellent anti-vibration and airtight characteristics. Greater tensile strength at the corresponding materials' surface of contact. Increases the strength of the application material.
Large flange	NSA-LF	The large flange diameter of these rivets make them suitable for use with soft materials, such as plastic boards, FRP, plywood, etc.	Heavy duty	S-bolt	Strong, good clamping strength, anti-vibration and airtight characteristics.
	AP	This type of rivet can clamp material of larger thicknesses than before, so it is possible to use a single rivet type to fasten a wider range of materials. Excellent airtight characteristics and also appropriate for use with soft boards.			

Type	Flange Type	Model	Material		Rivet Diameter					Page
			Rivet	Shaft	2.4	3.2	4.0	4.8	6.4	
Standard	Domed Head	NSA	Aluminum	Steel	●	●	●	●	●	P.20
		NTA	Aluminum	Stainless steel	●	●	●	●	●	P.21
		NA	Aluminum	Aluminum	●	●	●	●	●	P.22
		NS	Steel	Steel	●	●	●	●	●	P.23
		NST	Stainless steel	Stainless steel	●	●	●	●	●	P.24
		NSS	Stainless steel	Steel	●	●	●	●	●	P.25
Large Flange	Domed Head	NSA-LF	Aluminum	Steel			●	●		P.26
Bulb	Domed Head	AP	Aluminum	Steel		●	●	●		P.27
		NSTB	Stainless steel	Stainless steel				●		P.28
Shield	Domed Head	NSA-C	Aluminum	Steel			●	●		P.27
Colored	Domed Head	CNSA	Aluminum	Steel		●	●			P.28
Structural (Bolt)	Domed Head	SNS	Steel	Steel				●	●	P.29
	Countersunk Head	SNS-K	Steel	Steel					●	P.29

Blind Rivets

With an aluminum rivet body and steel shaft, this standard rivet has a wide range of applications.

NSA Domed head

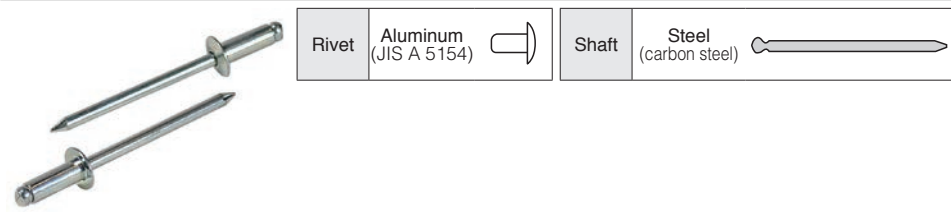
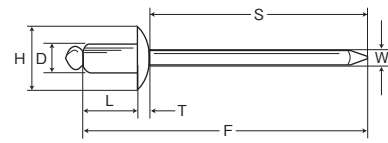

Rivet diameter D φ mm	Hole diameter φ mm	Model	Appropriate material thickness mm	Dimensions						Strength		per package								
				L mm	H φ mm	T mm	W φ mm	S mm	F mm	Tensile N	Shearing N									
2.4	2.5~2.6	NSA3-2	1.0~3.2	5.6	4.8	0.9	1.45	28.5	35	700	450	1,000								
		NSA3-3	1.6~4.8	7.6				26.5	35											
		NSA3-4	3.2~6.4	9.1				25.0	35											
		NSA4-1	1.0~1.6	4.8				32.1	38											
3.2	3.3~3.4	NSA4-2	1.0~3.2	6.5	6.4	1.1	1.8	30.4	38	1,350	950	1,000								
		NSA4-3	1.6~4.8	8.2				28.7	38											
		NSA4-4	3.2~6.4	9.9				27.0	38											
		NSA4-5	4.8~8.0	11.6				29.3	42											
		NSA4-6	6.4~9.5	13.3				27.6	42											
		NSA4-8	9.5~12.7	16.7				27.2	45											
		NSA4-10	12.7~15.9	19.0			32.9	53	1,300	850	1,000									
		NSA4-12	15.9~19.1	23.0			28.9	53												
		4.0	4.1~4.2	NSA5-2			1.2~3.2	7.2	8.0	1.3	2.24	33.5	42	2,200	1,550	1,000				
				NSA5-3			1.6~4.8	8.9				31.8	42							
				NSA5-4			3.2~6.4	10.5				30.2	42							
				NSA5-5			4.8~8.0	12.2				28.5	42							
NSA5-6	6.4~9.5			13.9	32.8	48														
NSA5-8	9.5~12.7			17.2	29.5	48														
NSA5-10	12.7~15.9			19.7	34.0	55														
NSA5-12	15.9~19.1			23.0	30.7	55														
4.8	4.9~5.0			NSA6-2	1.6~3.2	7.6	9.6	1.9				2.64	38.5				48	3,300	2,200	1,000
				NSA6-3	1.6~4.8	9.3							36.8				48			
		NSA6-4	3.2~6.4	11.0	35.1	48														
		NSA6-5	4.8~8.0	12.8	33.3	48														
		NSA6-6	6.4~9.5	14.5	41.6	56														
		NSA6-8	9.5~12.7	17.9	38.2	56														
		NSA6-10	12.7~15.9	21.3	36.0	56														
		NSA6-12	15.9~19.1	24.8	34.9	60														
		NSA6-14	19.1~22.3	28.2	39.6	66			500											
		NSA6-16	22.3~25.4	29.7	36.4	66														
		6.4	6.5~6.6	NSA8-2	1.6~3.2	9.2				12.8	2.4		3.83	48.4	60	5,300	3,400			500
				NSA8-4	3.2~6.4	12.4								45.2	60					
				NSA8-6	6.4~9.5	15.6			42.0					60						
				NSA8-8	9.5~12.7	18.9			38.7					60						
NSA8-10	12.7~15.9			22.1	45.5	70														
NSA8-12	15.9~19.1			25.4	42.2	70														
NSA8-14	19.1~22.3			28.6	39.0	70														

Blind Rivets

The strength is same as NSA and a corrosion resistance.

NTA Domed head

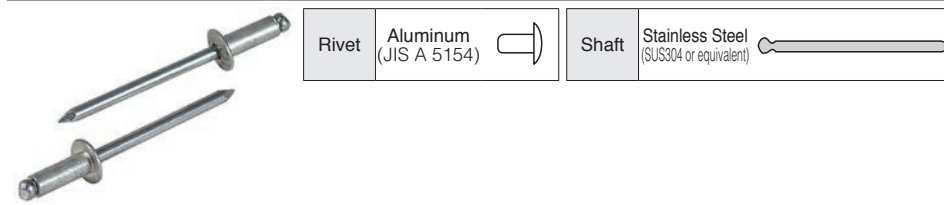
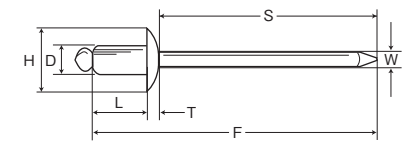

Rivet diameter D φ mm	Hole diameter φ mm	Model	Appropriate material thickness mm	Dimensions						Strength		per package								
				L mm	H φ mm	T mm	W φ mm	S mm	F mm	Tensile N	Shearing N									
2.4	2.5~2.6	NTA3-2	1.0~3.2	5.6	4.8	0.9	1.45	28.5	35	700	450	1,000								
		NTA3-3	1.6~4.8	7.6				26.5	35											
		NTA3-4	3.2~6.4	9.1				25.0	35											
3.2	3.3~3.4	NTA4-1	1.0~1.6	4.8	6.4	1.1	1.8	32.1	38	1,350	950	1,000								
		NTA4-2	1.0~3.2	6.5				30.4	38											
		NTA4-3	1.6~4.8	8.2				28.7	38											
		NTA4-4	3.2~6.4	9.9				27.0	38											
		NTA4-5	4.8~8.0	11.6				29.3	42											
		NTA4-6	6.4~9.5	13.3				27.6	42											
		NTA4-8	9.5~12.7	16.7			27.2	45	1,300	850	1,000									
		NTA4-10	12.7~15.9	19.0			32.9	53												
		NTA4-12	15.9~19.1	23.0			28.9	53												
		4.0	4.1~4.2	NTA5-2			1.2~3.2	7.2	8.0	1.3	2.24	33.5	42	2,200	1,550	1,000				
				NTA5-3			1.6~4.8	8.9				31.8	42							
				NTA5-4			3.2~6.4	10.5				30.2	42							
NTA5-5	4.8~8.0			12.2	28.5	42														
NTA5-6	6.4~9.5			13.9	32.8	48														
NTA5-8	9.5~12.7			17.2	29.5	48														
NTA5-10	12.7~15.9			19.7	34.0	55														
NTA5-12	15.9~19.1			23.0	30.7	55														
4.8	4.9~5.0			NTA6-2	1.6~3.2	7.6	9.6	1.9				2.64	38.5				48	3,300	2,200	1,000
				NTA6-3	1.6~4.8	9.3							36.8				48			
		NTA6-4	3.2~6.4	11.0	35.1	48														
		NTA6-5	4.8~8.0	12.8	33.3	48														
		NTA6-6	6.4~9.5	14.5	41.6	58														
		NTA6-8	9.5~12.7	17.9	38.2	58														
		NTA6-10	12.7~15.9	21.3	36.0	58														
		NTA6-12	15.9~19.1	24.8	34.9	60														
		NTA6-14	19.1~22.3	28.2	39.6	66			500											
		NTA6-16	22.3~25.4	29.7	36.4	66														
		6.4	6.5~6.6	NTA8-2	1.6~3.2	9.2				12.8	2.4		3.83	48.4	60	5,300	3,400			500
				NTA8-4	3.2~6.4	12.4								45.2	60					
				NTA8-6	6.4~9.5	15.6			42.0					60						
				NTA8-8	9.5~12.7	18.9			38.7					60						
NTA8-10	12.7~15.9			22.1	45.5	70														
NTA8-12	15.9~19.1			25.4	42.2	70														
NTA8-14	19.1~22.3			28.6	39.0	70														

WARNING For all Blind rivets • Be sure that you understand all of the work conditions involved before using blind rivets. • Before starting work, ALWAYS read the instruction manual for your riveter tool.

Blind Rivets

Blind Rivets

These all-aluminum rivets have a high corrosion resistance and are appropriate for fastening together aluminum plates or soft materials like resin.



NA Domed head

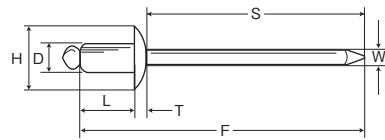

Rivet diameter D φ mm	Hole diameter φ mm	Model	Appropriate material thickness mm	Dimensions						Strength		per package
				L mm	H φ mm	T mm	W φ mm	S mm	F mm	Tensile N	Shearing N	
2.4	2.5~2.6	NA3-2	1.0~3.2	5.6	4.8	0.9	1.5	28.5	35	650	450	1,000
		NA3-3	1.6~4.8	7.6				26.5	35			
		NA3-4	3.2~6.4	9.1				25.0	35			
3.2	3.3~3.4	NA4-1	1.0~1.6	4.8	6.4	1.1	1.9	32.1	38	1,000	750	1,000
		NA4-2	1.0~3.2	6.5				30.4	38			
		NA4-3	1.6~4.8	8.2				28.7	38			
		NA4-4	3.2~6.4	9.9				27.0	38			
		NA4-5	4.8~8.0	11.6				29.3	42			
		NA4-6	6.4~9.5	13.3				27.6	42			
		NA4-8	9.5~12.7	16.7				24.2	45			
		NA4-10	12.7~15.9	19.0				32.9	53			
		NA4-12	15.9~19.1	23.0				28.9	53			
		4.0	4.1~4.2	NA5-2				1.2~3.2	7.2			
NA5-3	1.6~4.8			8.9	31.8	42						
NA5-4	3.2~6.4			10.5	30.2	42						
NA5-5	4.8~8.0			12.2	28.5	42						
NA5-6	6.4~9.5			13.9	32.8	48						
NA5-8	9.5~12.7			17.2	29.5	48						
NA5-10	12.7~15.9			19.7	34.0	55						
NA5-12	15.9~19.1			23.0	30.7	55						
4.8	4.9~5.0	NA6-2	1.6~3.2	7.6	9.6	1.9	2.9	38.5	48	2,350	1,600	1,000
		NA6-3	1.6~4.8	9.3				36.8	48			
		NA6-4	3.2~6.4	11.0				35.1	48			
		NA6-5	4.8~8.0	12.8				33.3	48			
		NA6-6	6.4~9.5	14.5				39.6	56			
		NA6-8	9.5~12.7	17.9				36.2	56			
		NA6-10	12.7~15.9	21.3				34.0	56			
		NA6-12	15.9~19.1	24.8				34.9	60			
		NA6-14	19.1~22.3	28.2				37.6	66			
		NA6-16	22.3~25.4	29.7				34.4	66			
6.4	6.5~6.6	NA8-2	1.6~3.2	9.2	12.8	2.4	3.8	48.9	60	4,200	2,650	500
		NA8-4	3.2~6.4	12.4				45.7	60			
		NA8-6	6.4~9.5	15.6				42.5	60			
		NA8-8	9.5~12.7	18.9				39.2	60			
		NA8-10	12.7~15.9	22.1				46.0	70			
		NA8-12	15.9~19.1	25.4				42.7	70			
		NA8-14	19.1~22.3	28.6				39.5	70			

Blind Rivets

These all-steel rivets have a high strength and are appropriate for fastening steel pieces together.



NS Domed head

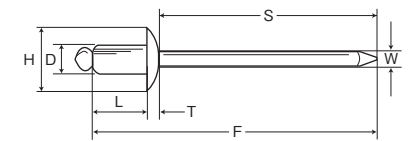
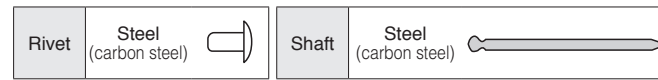

Rivet diameter D φ mm	Hole diameter φ mm	Model	Appropriate material thickness mm	Dimensions						Strength		per package
				L mm	H φ mm	T mm	W φ mm	S mm	F mm	Tensile N	Shearing N	
2.4	2.5~2.6	NS3-2	1.0~3.2	5.5	4.8	0.8	1.5	28.8	35	850	700	1,000
		NS3-4	3.2~6.4	8.7				25.6	35			
3.2	3.3~3.4	NS4-1	1.0~1.6	4.8	6.4	1.1	1.9	32.1	38	1,700	1,300	1,000
		NS4-2	1.0~3.2	6.4				30.5	38			
		NS4-3	1.6~4.8	8.0				28.9	38			
		NS4-4	3.2~6.4	9.5				27.4	38			
		NS4-5	4.8~8.0	11.2				29.7	42			
		NS4-6	6.4~9.5	12.7				28.2	42			
		NS4-8	9.5~12.7	15.9				25.0	42			
		NS4-10	12.7~15.9	19.0				24.2	45			
4.0	4.1~4.2	NS5-2	1.2~3.2	7.0	8.0	1.3	2.4	33.7	44	2,700	2,000	1,000
		NS5-3	1.6~4.8	8.6				32.7	44			
		NS5-4	3.2~6.4	10.2				30.5	44			
		NS5-5	4.8~8.0	11.8				28.9	44			
		NS5-6	6.4~9.5	13.3				32.4	48			
		NS5-8	9.5~12.7	16.5				29.2	48			
		NS5-10	12.7~15.9	19.7				28.5	48			
		NS5-12	15.9~19.1	23.0				36.9	48			
4.8	4.9~5.0	NS6-2	1.6~3.2	7.6	9.6	1.8	2.9	38.5	48	4,000	3,000	1,000
		NS6-3	1.6~4.8	9.2				36.9	48			
		NS6-4	3.2~6.4	10.8				35.3	48			
		NS6-5	4.8~8.0	12.4				33.7	48			
		NS6-6	6.4~9.5	14.0				40.1	56			
		NS6-8	9.5~12.7	17.2				36.9	56			
		NS6-10	12.7~15.9	20.4				33.7	56			
		NS6-12	15.9~19.1	23.6				34.5	60			
		NS6-14	19.1~22.3	26.8				34.4	66			
		6.4	6.5~6.6	NS8-4				3.2~6.4	12.4			12.7
NS8-6	6.4~9.5			15.6	42.8	60						
NS8-8	9.5~12.7			18.9	39.2	60						
NS8-10	12.7~15.9			22.1	36.0	70						
NS8-12	15.9~19.1			25.4	32.7	70						
NS8-14	19.1~22.3			28.6	29.5	70						

WARNING

For all Blind rivets

- Be sure that you understand all of the work conditions involved before using blind rivets.
- Before starting work, ALWAYS read the instruction manual for your riveter tool.

Blind Rivets

Blind Rivets

With a stainless steel rivet body and steel shaft, the corrosion resistance of these rivets is inferior to NST rivets, but their strength is equivalent.



NSS Domed head

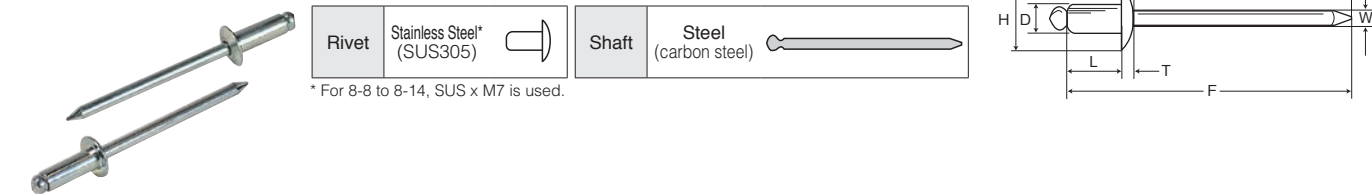

Rivet diameter D φ mm	Hole diameter φ mm	Model	Appropriate material thickness mm	Dimensions						Strength		per package
				L mm	H φ mm	T mm	W φ mm	S mm	F mm	Tensile N	Shearing N	
2.4	2.5~2.6	NSS3-2	1.0~3.2	5.5	4.8	0.6	1.5	29.0	35	1,300	1,100	1,000
		NSS3-4	3.2~6.4	8.7				25.8	35			
3.2	3.3~3.4	NSS4-1	1.0~1.6	4.4	6.4	0.8	2.0	33.0	38	2,700	2,350	1,000
		NSS4-2	1.0~3.2	6.0				31.4	38			
		NSS4-3	1.6~4.8	7.6				29.8	38			
		NSS4-4	3.2~6.4	9.2				28.2	38			
		NSS4-5	4.8~8.0	10.8				30.6	42			
		NSS4-6	6.4~9.5	12.3				29.1	42			
		NSS4-8	9.5~12.7	15.5				25.9	42			
		NSS5-2	1.2~3.2	6.6				34.6	42			
4.0	4.1~4.2	NSS5-3	1.6~4.8	8.2	7.9	1.0	2.5	33.0	42	3,950	3,400	1,000
		NSS5-4	3.2~6.4	9.8				31.4	42			
		NSS5-5	4.8~8.0	11.4				29.8	42			
		NSS5-6	6.4~9.5	12.9				33.3	47			
		NSS5-8	9.5~12.7	16.1				30.1	47			
		NSS6-2	1.6~3.2	7.1				39.7	48			
4.8	4.9~5.0	NSS6-3	1.6~4.8	9.0	9.5	1.4	2.85	37.8	48	6,350	5,450	1,000
		NSS6-4	3.2~6.4	10.3				36.5	48			
		NSS6-5	4.8~8.0	11.9				34.9	48			
		NSS6-6	6.4~9.5	13.5				41.3	56			
		NSS6-8	9.5~12.7	16.7				38.1	56			
		NSS6-10	12.7~15.9	19.9				34.9	60			
		NSS6-12	15.9~19.1	23.0				35.8	60			
		NSS6-14	19.1~22.3	26.5				38.3	66			
		NSS6-16	22.3~25.4	29.7				35.1	66			
		6.4	6.5~6.6	NSS8-4				3.2~6.4	12.4			12.8
NSS8-6	6.4~9.5			15.6	42.8	60						
NSS8-8	9.5~12.7			18.9	12.5	1.9	3.9	39.5	60	10,500	8,500	
NSS8-10	12.7~15.9			22.1				46.3	70			
NSS8-12	15.9~19.1			25.4				43.0	70			
NSS8-14	19.1~22.3			28.6				39.8	70			

Blind Rivets

These all-stainless steel rivets have top strength and top corrosion resistance.



NST Domed head

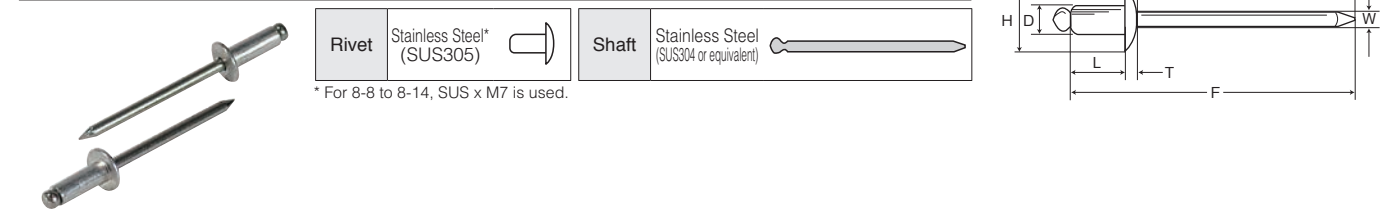

Rivet diameter D φ mm	Hole diameter φ mm	Model	Appropriate material thickness mm	Dimensions						Strength		per package
				L mm	H φ mm	T mm	W φ mm	S mm	F mm	Tensile N	Shearing N	
2.4	2.5~2.6	NST3-2	1.0~3.2	5.5	4.8	0.6	1.5	29.0	35	1,300	1,100	1,000
		NST3-4	3.2~6.4	8.7				25.8	35			
3.2	3.3~3.4	NST4-1	1.0~1.6	4.4	6.4	0.8	2.0	33.0	38	2,700	2,350	1,000
		NST4-2	1.0~3.2	6.0				31.4	38			
		NST4-3	1.6~4.8	7.6				29.8	38			
		NST4-4	3.2~6.4	9.2				28.2	38			
		NST4-5	4.8~8.0	10.8				30.6	42			
		NST4-6	6.4~9.5	12.3				29.1	42			
		NST4-8	9.5~12.7	15.5				25.9	42			
		NST5-2	1.2~3.2	6.6				34.6	42			
4.0	4.1~4.2	NST5-3	1.6~4.8	8.2	7.9	1.0	2.5	33.0	42	3,950	3,400	1,000
		NST5-4	3.2~6.4	9.8				31.4	42			
		NST5-5	4.8~8.0	11.4				29.8	42			
		NST5-6	6.4~9.5	12.9				33.3	47			
		NST5-8	9.5~12.7	16.1				30.1	47			
		NST6-2	1.6~3.2	7.1				39.7	48			
4.8	4.9~5.0	NST6-3	1.6~4.8	9.0	9.5	1.4	2.9	37.8	48	6,350	5,450	1,000
		NST6-4	3.2~6.4	10.3				36.5	48			
		NST6-5	4.8~8.0	11.9				34.9	48			
		NST6-6	6.4~9.5	13.5				41.3	56			
		NST6-8	9.5~12.7	16.7				38.1	56			
		NST6-10	12.7~15.9	19.9				34.9	60			
		NST6-12	15.9~19.1	23.0				35.8	60			
		NST6-14	19.1~22.3	26.5				38.3	66			
		NST6-16	22.3~25.4	29.7				35.1	66			
		6.4	6.5~6.6	NST8-4				3.2~6.4	12.4			12.8
NST8-6	6.4~9.5			15.6	42.8	60						
NST8-8	9.5~12.7			18.9	12.5	1.9	3.9	39.5	60	10,500	8,500	
NST8-10	12.7~15.9			22.1				46.3	70			
NST8-12	15.9~19.1			25.4				43.0	70			
NST8-14	19.1~22.3			28.6				39.8	70			

WARNING For all Blind rivets • Be sure that you understand all of the work conditions involved before using blind rivets. • Before starting work, ALWAYS read the instruction manual for your riveter tool.

Blind Rivets

These rivets are a countersunk type head. By preparing a countersunk hole in the base material, the flange will not protrude and will end up flush with the surface of the material.

NSA-K Countersunk head

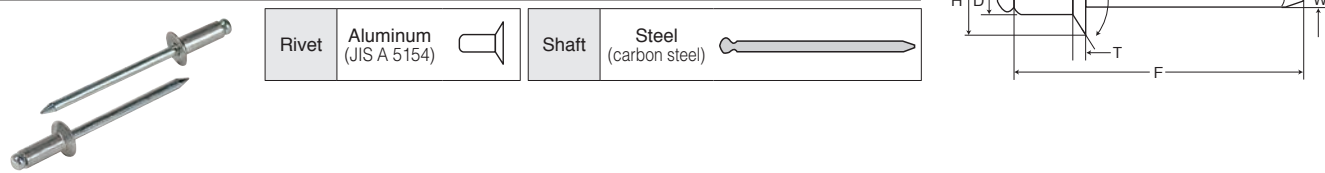

Rivet diameter D φ mm	Hole diameter φ mm	Model	Appropriate material thickness mm	Dimensions						Strength		per package
				L mm	H φ mm	T mm	W φ mm	S mm	F mm	Tensile N	Shearing N	
2.4	2.5~2.6	NSA3-2K	1.6~3.2	5.6	4.8	0.8	1.45	28.6	35	600	450	1,000
		NSA3-4K	3.2~6.4	9.1				25.1	35			
3.2	3.3~3.4	NSA4-2K	1.6~3.2	6.5	6.4	1.2	1.8	30.3	38	1,350	950	1,000
		NSA4-3K	1.6~4.8	8.2				28.6	38			
		NSA4-4K	3.2~6.4	9.9				26.9	38			
		NSA4-5K	4.8~8.0	11.6				29.2	42			
		NSA4-6K	6.4~9.5	13.3				27.5	42			
		NSA4-8K	9.5~12.7	16.7				27.1	45			
		NSA5-2K	1.2~3.2	7.2				33.4	42			
		NSA5-3K	1.6~4.8	8.9				31.7	42			
4.0	4.1~4.2	NSA5-4K	3.2~6.4	10.5	8.0	1.5	2.24	30.1	42	2,100	1,450	1,000
		NSA5-5K	4.8~8.0	12.2				28.4	42			
		NSA5-6K	6.4~9.5	13.9				32.7	48			
		NSA5-8K	9.5~12.7	17.2				29.4	48			
		NSA6-2K	2.4~3.2	7.6				38.7	48			
		NSA6-3K	2.4~4.8	9.3				37.0	48			
4.8	4.9~5.0	NSA6-4K	3.2~6.4	11.0	9.6	1.7	2.64	35.3	48	3,250	2,250	1,000
		NSA6-5K	4.8~8.0	12.8				43.5	48			
		NSA6-6K	6.4~9.5	14.5				41.8	58			
		NSA6-8K	9.5~12.7	17.9				38.4	58			
		NSA6-10K	12.7~15.9	20.1				36.2	58			

Large-flange Blind Rivets

These rivets are a large flange diameter. Even if the side of the base material where the flange is located is of a soft material, there is minimal deforming of that material and it is possible to use a large diameter hole on that side.

NSA-LF Domed head

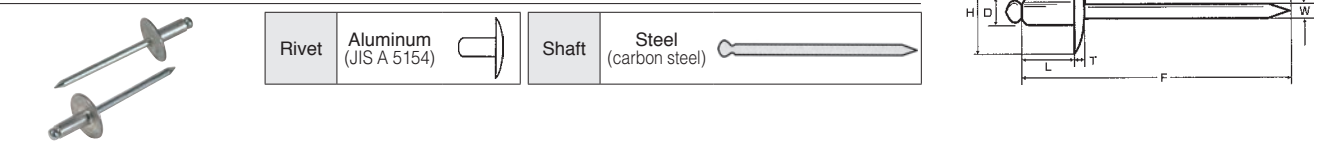

Rivet diameter D φ mm	Hole diameter φ mm	Part number	Appropriate material thickness mm	Dimensions						Strength		per package
				L mm	H φ mm	T mm	W φ mm	S mm	F mm	Tensile N	Shearing N	
4.0	4.1~4.2	NSA5-4LF	3.2~6.4	10.5	12.0	1.7	2.24	29.8	42	2,200	1,550	1,000
		NSA5-5LF	4.8~8.0	12.2				28.1	42			
		NSA5-6LF	6.4~9.5	13.9				32.4	48			
		NSA5-8LF	9.5~12.7	17.2				29.1	48			
4.8	4.9~5.0	NSA6-2LF	1.6~3.2	7.6	15.9	2.2	2.64	38.2	48	3,300	2,200	500
		NSA6-3LF	1.6~4.8	9.3				36.5	48			
		NSA6-4LF	3.2~6.4	11.0				34.8	48			
		NSA6-5LF	4.8~8.0	12.8				33.0	48			
		NSA6-6LF	6.4~9.5	14.5				41.3	58			
		NSA6-8LF	9.5~12.7	17.9				37.9	58			
		NSA6-10LF	12.7~15.9	21.3				35.7	58			
		NSA6-12LF	15.9~19.1	23.3				34.5	60			
		NSA6-14LF	19.1~22.3	26.5				39.3	68			
		NSA6-16LF	22.3~25.4	29.7				36.1	68			

AP Rivets

AP rivets can be used with a wide range of material thicknesses, so it is possible to use this one rivet type to fasten a wider range of materials. Displays excellent airtight characteristics and is also appropriate for use with soft material as well.

AP Domed head

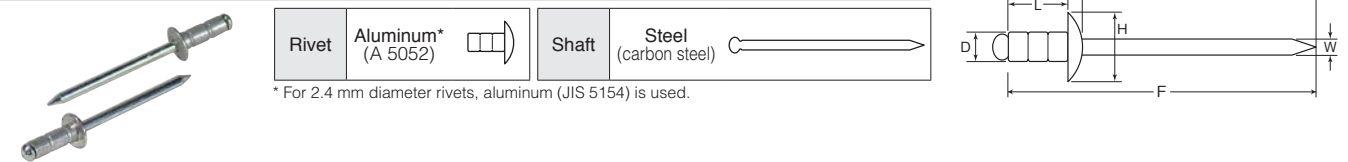

Rivet diameter D φ mm	Hole diameter φ mm	Model	Appropriate material thickness mm	Dimensions						Strength		per package
				L mm	H φ mm	T mm	W φ mm	S mm	F mm	Tensile N	Shearing N	
3.2	3.4~3.5	AP4-3	1.0~4.8	8.2	6.4	1.1	1.9	28.7	38	1,000	750	1,000
		AP4-5	4.8~8.0	13.3				27.6	42			
4.0	4.2~4.3	AP5-4	1.2~6.4	10.5	8.0	1.3	2.4	30.2	42	1,600	1,150	1,000
4.8	5.0~5.1	AP6-4	1.6~6.4	11.0	9.5	1.9	2.9	35.1	48	2,350	1,600	1,000
		AP6-8	6.4~12.7	18.5				35.6	56			

Blind Rivets (shield type)

NSA-C rivets have a high airtight and a high antivibration. They also eliminate the worry of dropping the leftover shaft head.

NSA-C Domed head

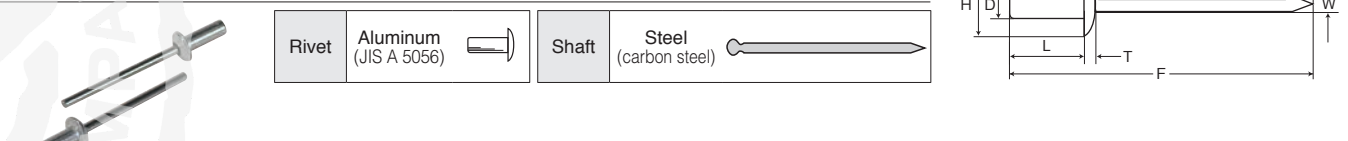

Rivet diameter D φ mm	Hole diameter φ mm	Model	Appropriate material thickness mm	Dimensions						Strength		per package
				L mm	H φ mm	T mm	W φ mm	S mm	F mm	Tensile N	Shearing N	
4.0	4.1~4.2	NSA5-2C	1.2~3.2	8.0	8.0	1.8	2.18	32.2	42	2,550	1,800	1,000
		NSA5-3C	1.6~4.8	9.6				30.6	42			
		NSA5-4C	3.2~6.4	11.2				29.1	42			
		NSA5-5C	4.8~8.0	12.8				30.4	45			
		NSA5-6C	6.4~9.5	14.4				28.8	45			
4.8	4.9~5.0	NSA6-2C	1.6~3.2	8.5	9.6	2.4	2.66	34.4	45	3,900	2,600	1,000
		NSA6-3C	1.6~4.8	10.0				32.9	45			
		NSA6-4C	3.2~6.4	11.6				31.3	45			
		NSA6-5C	4.8~8.0	13.1				32.8	48			
		NSA6-6C	6.4~9.5	14.7				31.2	48			
		NSA6-8C	9.5~12.7	17.9				30.0	50			

WARNING For all Blind rivets • Be sure that you understand all of the work conditions involved before using blind rivets. • Before starting work, ALWAYS read the instruction manual for your riveter tool.

Colored Blind Rivets

Utilizing blind rivets with a pre-colored flange eliminates the need to paint the rivets and offers an attractive finish. Available in your preferred color.

C-NSA Domed head

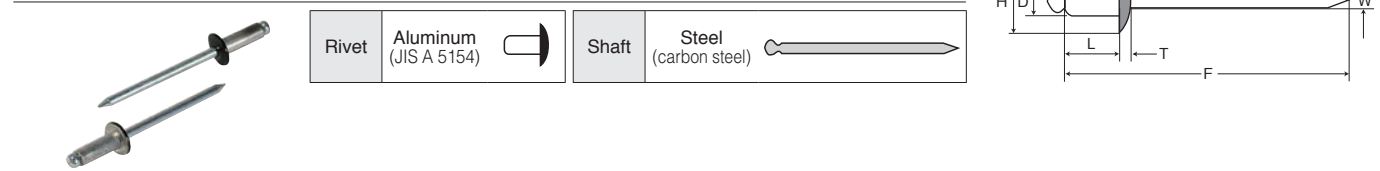

Color	Rivet diameter D φ mm	Hole diameter φ mm	Model	Appropriate material thickness mm	Dimensions						Strength		per package
					L mm	H φ mm	T mm	W φ mm	S mm	F mm	Tensile N	Shearing N	
Bronze	3.2	3.3~3.4	C-NSA4-2BR	1.0~3.2	6.5	6.4	1.1	1.8	30.4	38	1,350	950	1,000
			C-NSA4-3BR	1.6~4.8	8.2				27.0				
			C-NSA4-4BR	3.2~6.4	9.9				27.0				
	4.0	4.1~4.2	C-NSA5-2BR	1.2~3.2	7.2	8.0	1.3	2.24	33.5	42	2,200	1,550	
			C-NSA5-3BR	1.6~4.8	8.9				31.8				
			C-NSA5-4BR	3.2~6.4	10.5				30.2				
White	3.2	3.3~3.4	C-NSA4-2W	1.0~3.2	6.5	6.4	1.1	1.8	30.4	38	1,350	950	1,000
			C-NSA4-3W	1.6~4.8	8.2				28.7				
			C-NSA4-4W	3.2~6.4	9.9				27.0				
	4.0	4.1~4.2	C-NSA5-2W	1.2~3.2	7.2	8.0	1.3	2.24	33.5	42	2,200	1,550	
			C-NSA5-3W	1.6~4.8	8.9				31.8				
			C-NSA5-4W	3.2~6.4	10.5				30.2				
Black	3.2	3.3~3.4	C-NSA4-2B	1.0~3.2	6.5	6.4	1.1	1.8	30.4	38	1,350	950	1,000
			C-NSA4-3B	1.6~4.8	8.2				28.7				
			C-NSA4-4B	3.2~6.4	9.9				27.0				
	4.0	4.1~4.2	C-NSA5-2B	1.2~3.2	7.2	8.0	1.3	2.24	33.5	42	2,200	1,550	
			C-NSA5-3B	1.6~4.8	8.9				31.8				
			C-NSA5-4B	3.2~6.4	10.5				30.2				

High Performance Blind Rivets Bulb-Type Rivets

Stainless steel bulb type NSTB rivet (φ4.8) offers excellent anti-vibration and airtight characteristics simply not available in conventional rivets!

NSTB

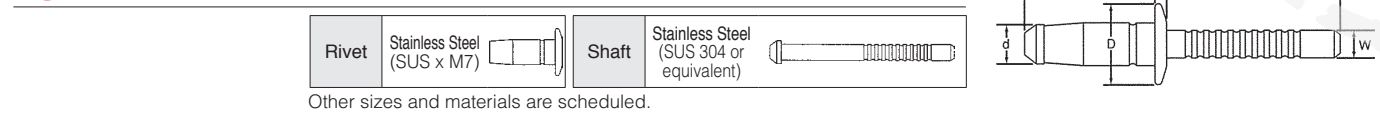

Other sizes and materials are scheduled.

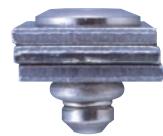

Riveted boards

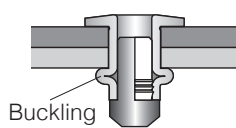

Buckling
Cross-sectional diagram of riveted boards

Superior anti-vibration and airtight characteristics

The "hole-fill" function employing special-shaped rivet and shaft ensures tight fit.

Greater tensile strength at the corresponding materials' surface of contact

Buckling is triple that of standard rivets of the same diameter, thus improving tensile strength at the corresponding material.

Increased strength of the application material

The axial strength is high in comparison to conventional rivets, adding high surface rigidity to the corresponding material. Because surface rigidity per unit of surface area is increased for veneer boards as well, a secure joint is ensured.

Applications
 Passenger vehicle bumpers PC servers
 Window shutters and sliding storm doors
 Refrigeration truck frames Computer racks
 Motorcycle mufflers

Specifications and performance

■ NSTB rivets [Materials] Rivet: stainless steel, Shaft: stainless steel

Model	D φ mm	d φ mm	T mm	L mm	E mm	W φ mm	Hole diameter (mm)	Appropriate material thickness	Tensile N	Shearing N	Mandrel removal strength N	per package
NSTB 6-3	9.5	4.8	1.4	14.0	27	3.2	4.9~5.1	1.6~4.8	5,800	5,500	1,000	1,000
NSTB 6-4	9.5	4.8	1.4	15.5	27	3.2	4.9~5.1	3.2~6.4	5,800	5,500	800	1,000
NSTB 6-6	9.5	4.8	1.4	19.5	27	3.2	4.9~5.1	6.4~9.6	5,500	6,500	800	1,000

High Strength Blind Rivets S-bolt (φ4.8, φ6.4)

Fastening from one side of the work, superior strength, and high anti-vibration performance makes S-bolt rivets appropriate for weldless work and for fastening important safety-related parts!

The stable supply, stable quality, and reasonable cost performance of S-bolts are all achieved through domestic production!



Locking construction

An original locking mechanism enables easier visual confirmation of the locked parts in comparison with other manufacturers' standard products and ensures secure lock.

"Hole fill" function

The rivet body itself is expanded during clamping, thus filling the lower hole more tightly and securing superior anti-vibration and weather-resistance conditions. We can supply data from JIS-standard vibration test for automotive parts. Various other tests (tensile, shearing and salt water atomization) can be performed as well.

High strength

Through a synergy of tensile, shearing, and shaft removal strength, S-bolt rivets have two to three times the strength of conventional blind rivets of the same diameter.

High anti-vibration characteristics

Excellent anti-vibration performance is achieved through an original locking mechanism and our unique "hole fill" function. This performance has been proven in JISD 1601 vibration tests for automotive parts.

High weather resistance

The rivet body itself is expanded during clamping, thus filling the lower hole more tightly and securing superior weather-resistance conditions.

Wide application range

Compared with conventional blind rivets of the same diameter, S-bolt rivets can fasten material up to twice the thicknesses than before, so it is not necessary to use multiple rivet sizes for different material thicknesses.

Single operation from one side of the work

Using LOBSTER riveters, anyone can easily obtain beautiful finish.

Fastening

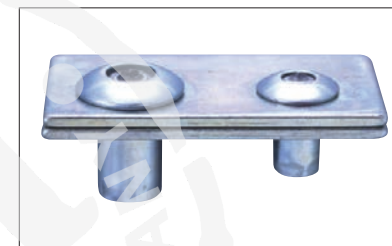

Cross-sectional diagram of fastening

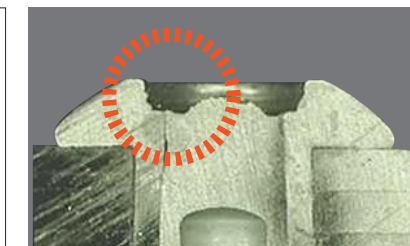

Specifications and performance

Domed head type

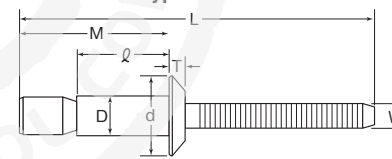

Countersunk type

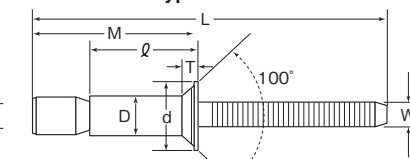

■ Steel ... Domed and countersunk types [Material] Rivet: steel (mid-carbon steel), Shaft: steel (low-carbon steel)

	Model	D φ mm	d φ mm	T mm	ℓ mm	M mm	L mm	W φ mm	Hole diameter (mm)	Appropriate material thickness	Tensile N	Shearing N	Shaft removal strength N	per package
Domed head type	SNS 48069	4.8	9.8	2.0	11.0	18.5	47.0	3.0	4.9~5.0	1.7~6.9	4,800	6,100	900	500
	SNS 48110				15.0	25.0	55.0			1.7~11.0				
	SNS 64095	6.4	13.0	2.6	14.5	24.0	55.0			2.1~9.5				
	SNS 64159				20.0	33.0	65.0			2.1~15.9				
Countersunk head type	SNS 64120K	6.4	10.0	2.1	17.0	27.0	55.0	4.0	6.6~7.0	3.2~12.0	9,800	11,300	1,100	250

WARNING

For all Blind rivets

- Be sure that you understand all of the work conditions involved before using blind rivets.
- Before starting work, ALWAYS read the instruction manual for your riveter tool.

Special Blind rivet (built to order)

	Rivet diameter mm	Hole diameter mm	Model	Appropriate material thickness mm	Dimensions		Strength	
					L mm	H φ mm	Tensile N	Shearing N
Large-flange Blind Rivets Rivet body: Aluminum Mandrel: Steel	3.2	3.3~3.4	NSA42LF	1.0~3.2	6.5	9.4	1350	960
	3.2	3.3~3.4	NSA43LF	1.6~4.8	8.2	9.4	1350	960
	3.2	3.3~3.4	NSA44LF	3.2~6.4	9.9	9.4	1350	960
	3.2	3.3~3.4	NSA45LF	4.8~8.0	11.6	9.4	1350	960
	3.2	3.3~3.4	NSA46LF	6.4~9.5	13.3	9.4	1350	960
	3.2	3.3~3.4	NSA48LF	9.5~12.7	16.7	9.4	1350	960
	4.0	4.1~4.2	NSA52LF	1.2~3.2	7.2	12.0	2200	1550
	4.0	4.1~4.2	NSA53LF	1.6~4.8	8.9	12.0	2200	1550
Blind Rivets (countersunk head) Rivet body: Steel Mandrel: Steel	3.2	3.3~3.4	NS42K	1.6~3.2	6.5	6.4	1400	1300
	3.2	3.3~3.4	NS43K	1.6~4.8	8.2	6.4	1400	1300
	3.2	3.3~3.4	NS44K	3.2~6.4	9.9	6.4	1400	1300
	4.0	4.1~4.2	NS53K	1.6~4.8	8.9	8.0	2200	2000
	4.0	4.1~4.2	NS54K	3.2~6.4	10.5	8.0	2200	2000
	4.0	4.1~4.2	NS56K	6.4~9.5	13.9	8.0	2200	2000
Blind Rivets (countersunk head) Rivet body: Stainless steel Mandrel: Stainless steel	3.2	3.3~3.4	NST42K	1.6~3.2	6.5	6.4	2500	2100
	3.2	3.3~3.4	NST43K	1.6~4.8	8.2	6.4	2500	2100
	3.2	3.3~3.4	NST44K	3.2~6.4	9.9	6.4	2500	2100
	4.0	4.1~4.2	NST52K	1.6~3.2	7.2	8.0	4200	3200
	4.0	4.1~4.2	NST53K	1.6~4.8	8.9	8.0	4200	3200
	4.0	4.1~4.2	NST54K	3.2~6.4	10.5	8.0	4200	3200
	4.8	4.9~5.0	NST62K	2.4~3.2	7.6	9.6	6000	4800
	4.8	4.9~5.0	NST63K	2.4~4.8	9.3	9.6	6000	4800
AP Rivets	4.8	5.0~5.1	AP612	12.7~19.1	26.5	9.6	2380	1680
	3.2	3.3~3.4	NSA41C	1.0~1.6	6.5	6.0	1600	1200
	3.2	3.3~3.4	NSA42C	1.6~3.2	8.0	6.0	1600	1200
Blind Rivets (shield type) Rivet body: Aluminum Mandrel: Steel	3.2	3.3~3.4	NSA43C	3.2~4.8	9.5	6.0	1600	1200
	3.2	3.3~3.4	NSA44C	4.8~6.4	11.0	6.0	1600	1200
	3.2	3.3~3.4	NSA45C	6.4~8.0	13.0	6.0	1600	1200
	4.8	4.9~5.0	NSA610C	12.7~15.9	23.0	9.6	3900	2600
	6.4	6.5~6.6	NSA84C	3.2~6.4	12.7	12.7	6000	4000
	6.4	6.5~6.6	NSA86C	6.4~9.5	15.9	12.7	6000	4000
Blind Rivets (shield type) Rivet body: stainless steel Mandrel: Stainless steel	3.2	3.3~3.4	NST41C	1.0~1.6	6.5	6.0	3000	2700
	3.2	3.3~3.4	NST42C	1.6~3.2	7.0	6.0	3000	2700
	3.2	3.3~3.4	NST43C	3.2~4.8	9.0	6.0	3000	2700
	3.2	3.3~3.4	NST44C	4.8~6.4	11.0	6.0	3000	2700
	3.2	3.3~3.4	NST45C	6.4~8.0	13.0	6.0	3000	2700
	4.0	4.1~4.2	NST52C	1.2~3.2	8.0	8.0	4300	4000
	4.0	4.1~4.2	NST53C	3.2~4.8	10.0	8.0	4300	4000
	4.0	4.1~4.2	NST54C	4.8~6.4	11.0	8.0	4300	4000
	4.0	4.1~4.2	NST55C	6.4~8.0	13.0	8.0	4300	4000
	4.0	4.1~4.2	NST56C	8.0~9.5	14.0	8.0	4300	4000
	4.8	4.9~5.0	NST62C	1.6~3.2	8.0	9.5	6000	5500
	4.8	4.9~5.1	NST63C	3.2~4.8	10.0	9.5	6000	5500
	4.8	4.9~5.2	NST64C	4.8~6.4	12.0	9.5	6000	5500
	4.8	4.9~5.3	NST65C	6.4~8.0	13.5	9.5	6000	5500
Blind Rivets (shield type) Rivet body: Aluminum Mandrel: Stainless steel	4.8	4.9~5.4	NST66C	8.0~9.5	15.0	9.5	6000	5500
	4.8	4.9~5.5	NST68C	9.5~12.7	18.0	9.5	6000	5500
	4.8	4.9~5.6	NST610C	12.7~15.9	21.0	9.5	6000	5500
	4.0	4.1~4.2	NTA52C	1.2~3.2	8.0	8.0	2550	1820
	4.0	4.1~4.2	NTA53C	1.6~4.8	9.6	8.0	2550	1820
	4.0	4.1~4.2	NTA54C	3.2~6.4	11.2	8.0	2550	1820
	4.0	4.1~4.2	NTA55C	4.8~8.0	12.8	8.0	2550	1820
	4.0	4.1~4.2	NTA56C	6.4~9.5	14.4	8.0	2550	1820
	4.8	4.9~5.0	NTA62C	1.6~3.2	8.5	9.6	3900	2600
	4.8	4.9~5.0	NTA63C	1.6~4.8	10.0	9.6	3900	2600
Blind Rivets Rivet body: Copper Mandrel: Steel	4.8	4.9~5.0	NTA64C	3.2~6.4	11.6	9.6	3900	2600
	4.8	4.9~5.0	NTA65C	4.8~8.0	13.1	9.6	3900	2600
	4.8	4.9~5.0	NTA66C	6.4~9.5	14.7	9.6	3900	2600
	4.8	4.9~5.0	NTA68C	9.5~12.7	17.9	9.6	3900	2600
	3.2	3.3~3.4	NSC41	1.0~1.6	4.8	6.4	1400	950
	3.2	3.3~3.4	NSC42	1.0~3.2	6.4	6.4	1400	950
	3.2	3.3~3.4	NSC43	1.6~4.8	8.0	6.4	1400	950
	3.2	3.3~3.4	NSC44	3.2~6.4	9.5	6.4	1400	950
	3.2	3.3~3.4	NSC45	4.8~8.0	11.2	6.4	1400	950
	4.0	4.1~4.2	NSC52	1.2~3.2	7.0	8.0	2150	1550
Blind Rivets Rivet body: Copper Mandrel: Copper	4.0	4.1~4.2	NSC53	1.6~4.8	8.6	8.0	2150	1550
	4.0	4.1~4.2	NSC54	3.2~6.4	10.2	8.0	2150	1550
	4.0	4.1~4.2	NSC56	6.4~9.5	13.3	8.0	2150	1550
	3.2	3.3~3.4	NCC41	1.0 1.6	4.8	6.4	1400	950
	3.2	3.3~3.4	NCC42	1.0 3.2	6.4	6.4	1400	950
	3.2	3.3~3.4	NCC43	1.6 4.8	8.0	6.4	1400	950
	3.2	3.3~3.4	NCC44	3.2 6.4	9.5	6.4	1400	950
	3.2	3.3~3.4	NCC45	4.8 8.0	11.2	6.4	1400	950
	4.0	4.1~4.2	NCC52	1.2 3.2	7.0	8.0	2150	1550
	4.0	4.1~4.2	NCC53	1.6 4.8	8.6	8.0	2150	1550
	4.0	4.1~4.2	NCC54	3.2 6.4	10.2	8.0	2150	1550
	4.0	4.1~4.2	NCC56	6.4 9.5	13.3	8.0	2150	1550



Pneumatic Rivet Nut Setters
 N1A2 32

Electric Rivet Nut Setter
 EN-410 33

Attachment Rivet Nut Setter
 @N10d 33

Heavy Duty Type Hand Rivet Nut Setter
 HN-010 33

Hand Rivet Nut Setter
 HND-005 33

Hand Rivet Nut Setter Kits
 HND-105 33

Rivet Nuts
 NSD 36
 NAD 36
 NSK 36
 NAK 37
 NTK 37

LOBSTER Serrated Rivet Nuts
 NSK·NSD 37

ST Lock
 CNSH109P 38
 CNSH1013P 38
 CNSH1016P 38

Attachment ST Look Nutrunner
 @RS10i 38

Rivet Nuts & Rivet Nut Setters

Rivet Nut Setters & Rivet Nuts

Pneumatic Rivet Nut Setters

- ▶ Operating speed 40%up(comparing with previous LOBSTER model).
- ▶ POWER: Approximately 40%UP!!(Applicable to M12 rivet nuts).
- ▶ LIGHT WEIGHT: Approximately 20%weight saving!!(Compared with LOBSTER previous model).
- ▶ Easily insert rivet nuts(Simply push the rivet nut to the mandrel).
- ▶ Clutch mechanism(Make accurate installation and avoid working failure).
- ▶ Easy stroke adjustment(No need tools to adjust the stroke).
- ▶ Good weight balance for usability(Less fatigue).
- ▶ One-touch reverse(Reverse button for in case of accident).

N1A2

Nut Setting Capacity

Aluminum, steel, stainless steel
M3 M4 M5 M6 M8 M10 M12

SPEED

Operating speed
40% up comparing with previous LOBSTER model

POWER

Previous model **18kN**
N1A2 25kN **Approximately 40% UP!!**
Applicable to M12 rivet nuts

LIGHT WEIGHT

Previous model **2.6 kg**
N1A2 2.1 kg
Approximately 20% weight saving!!
(Compared with LOBSTER previous model)



Easily insert rivet nuts

Simply push the rivet nut to the mandrel

Clutch mechanism

Make accurate installation and avoid working failure

Easy stroke adjustment

No need tools to adjust the stroke

① Push the rivet nut to the mandrel for installation.

② Pull the trigger to set the rivet nut to the material.

Good weight balance for usability

Less fatigue

One-touch reverse

Reverse button for in case of accident

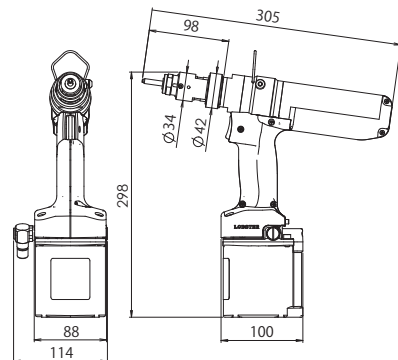

Model	Nut Setting Capacity ※1 ※2	Weight kg	Working Air Pressure MPa	Air Consumption L/nut
N1A2	(M3)•M4•M5•M6 M8•M10•(M12)	2.1	0.5~0.6	3.0

※1 When using M3, M12 rivet nuts, please purchase screw mandrel M3(64933)/M12(64939) and nosepiece M3(64940)/M12(64946) sold separately.
※2 Except rivet nuts unworkable within the tool specifications.

Electric Rivet Nut Setter

- ▶ M3 to M10 rivet nut can be used regardless of the base material.
- ▶ Easy-to-grip slender handle design.
- ▶ One-touch reverse-operation lever.
- ▶ Replacement of the insert relay is simple and has longer lifespan than before.

EN-410

Nut Setting Capacity

Aluminum, steel, stainless steel
M3 M4 M5 M6 M8 M10

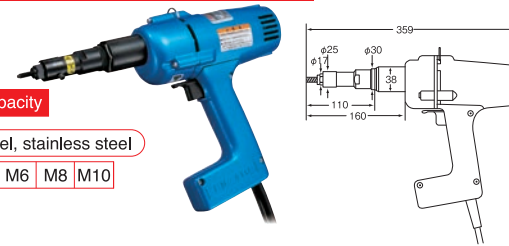

* If M3 is used, screw mandrel M3(14078) and nosepiece M3(10587) required.(sold separately)
* (AC220V, 50/60Hz
AC120V, 60Hz)

Model	Nut Setting Capacity	Weight kg	Power Supply	Power Consumption W	Current A	Code length m
EN-410	(M3)•M4•M5 M6•M8•M10	2.5	Optional*	305	3.3	2.5

Attachment Rivet Nut Setter

@N10d



Instantly turn your cordless driver drill (14.4V) into Attachment Rivet Nut Setter.
LOBSTER M4 to M6 rivet nuts can be fastened quickly.

Suitable for those who mainly use LOBSTER Rivet Nuts.
Not expensive than Pneumatic Rivet Nut Setter. Less fatigue than continuous work for Hand Rivet Nut Setter.

Model	Applicable Nut material	Nut Setting Capacity	Weight kg
@N10d	Aluminum:M4,M5,M6 Steel:M4,M5,M6	M4,M5,M6	0.45

Heavy Duty Type Hand Rivet Nut Setter

- ▶ Suitable for those who mainly use LOBSTER M8 and M10 rivet nuts.
- ▶ Installation and removal of LOBSTER rivet nuts can be accomplished quickly with one-touch operation of the round clip. Replacement of the screw mandrel when changing sizes is simple as well.

HN-010

Nut Setting Capacity

Aluminum, steel, stainless steel
M5 M6 M8 M10

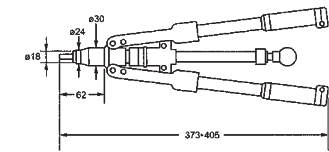

Model	Contents	Weight kg
HN-010	M5•M6•M8•M10	1.8

Hand Rivet Nut Setter

- ▶ Installation and removal of LOBSTER rivet nuts can be accomplished quickly with one-touch operation of the round clip. Replacement of the screw mandrel when changing sizes is simple as well.

HND-005

Nut Setting Capacity

Aluminum M4 M5 M6
Steel M3 M4 M5
Stainless steel M3 M4

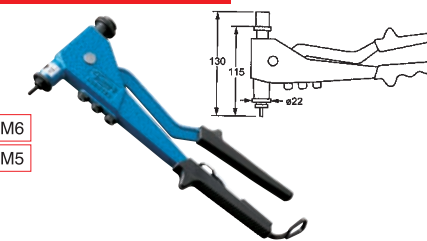

Model	Contents	Weight kg
HND-005	M3•M4•M5•M6 (Cannot be used with steel M6, stainless steel M5, and stainless steel M6.)	0.6

HND-105



Model	Contents	Weight kg
HND-105	HND005 hand rivet nut setter (1), LOBSTER NAD4M rivet nut (50), LOBSTER NAD5M rivet nut (50), LOBSTER NAD6M rivet nut (50)	1.74

WARNING

For all rivet nut setters

• Be sure to read the instruction manual carefully and make sure that you understand them thoroughly before using the rivet nut setter.

LOBSTER Blind Rivet Nuts

- ▶ Blind fasteners that combine the features of nut and rivet.
- ▶ Single-action fastening with a beautiful finish for use on thin boards where it is difficult to set a tap, or for round or square pipes and plastic boards where welding is not possible.
- ▶ Easy for anyone to install securely when used in conjunction with LOBSTER Pneumatic Rivet Nut Setter, Electric Rivet Nut Setter or Hand Rivet Nut Setter, and demonstrates an excellent capacity for lowering costs and saving labor.

LOBSTER Blind Rivet Nut Setters

Work Procedure

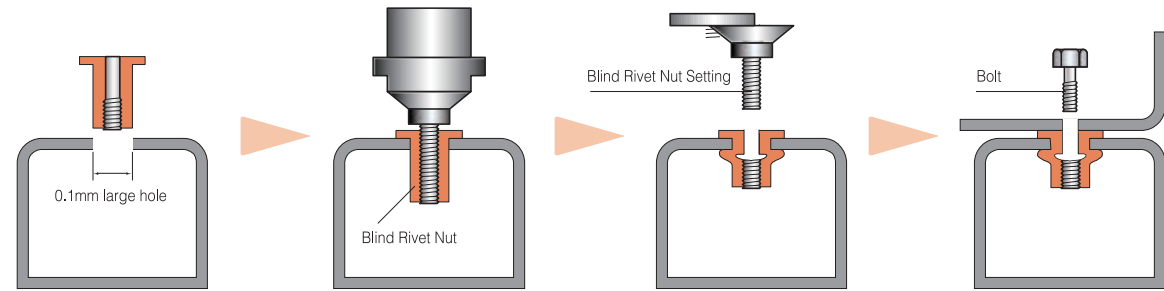

LOBSTER Blind Rivet Nuts Application Examples

Fastening an accessory piece to thin board

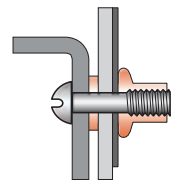

Fastening piping to flat board

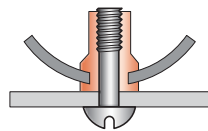

Leveling of farm tools/implements

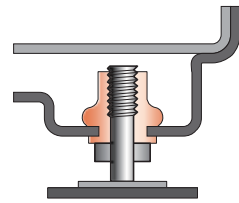

Attaching a latch to door

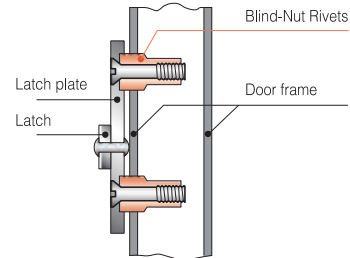
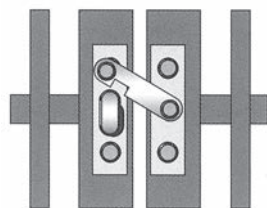

Applications

Household equipment

Storage sheds, doors, kitchen appliances, steel furniture, sash crescent stoppers, etc.

Household appliances

TV, stereo, air-conditioner, refrigerator, oven, etc.

Automotive

Accessories, malls, taillights, steps for RVs, etc.

Other

Electrical work, farm implements, interior/exterior work, solar equipment, etc.



Refrigerator height-adjuster stop



Stairway handrail bracket stop



Fastening windshield wipers



Carports



Doors

Blind Rivet Nuts

- **K Type** (NTK·NSK·NAK) **D Type** (NSD·NAD)



- Blind rivet fasteners that combine the features of a nut and rivet.
- Single-action riveting with a beautiful finish for use on thin boards where it is difficult to set a tap, or for round or square pipes and plastic boards where welding is not possible.
- Easy for anyone to install securely when used in conjunction with a LOBSTER Pneumatic Rivet Nut Setter, Electric Rivet Nut Setter or Hand Rivet Nut Setter, and demonstrates an excellent capacity for lowering costs and saving labor.

Blind Rivet Nuts with Serration



- Soft riveting makes the rivet nut perfect for use with thin or soft boards.
- 30% less riveting strength than standard rivets enables more delicate riveting.
- Tapered tip means ease-of-insert into holes, making rivet nuts suitable for use with auto riveting.
- The serrations on the shaft ensure a snug fit into the base material and virtually eliminate loosening.
- Deformation of thin boards is avoided, especially with the countersunk (flush) K-type rivet.

Selection Table of Proper Rivet Nuts

	Type	Model	Material	M3	M4	M5	M6	M8	M10	M12	Page
Standard Type	Large flange	NSD	Steel		●	●	●	●	●	●	P.32
		NAD	Aluminum		●	●	●	●	●		P.32
	Small flange	NSK	Steel	●	●	●	●	●	●	●	P.32
		NAK	Aluminum		●	●	●	●	●		P.33
Serrated Type	Large flange	NTK	Stainless Steel		●	●	●	●	●		P.33
		NSD-R	Steel		●	●	●	●	●		P.33
	Small flange	NSK-R	Steel		●	●	●	●	●		P.33

WARNING

For all Rivet nuts

- Be sure that you understand all of the work conditions involved before using rivet nuts.
- Before starting work, ALWAYS read the instruction manual for your rivet nut setter.

Rivet Nuts

Type D (Large flange)

● **NSD/Steel (JIS SWCH)**

※ made to order item



● **Dimensions**

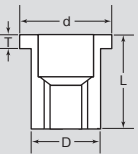

Model	Nut Setting Capacity	Hole diameter	Outer dimensions				Tensile N	Torque N · m	per package	Compatible screws
		mm	D(φmm)	d(φmm)	T(mm)	L(mm)				
NSD-4M	1.0~2.0	6.1	6.0	9.0	0.8	11.5	7,300	5.9	1,000	M4×0.7
NSD-415M	0.5~1.5	6.1	6.0	9.3	0.8	10.8	6,700	5.9	1,000	M4×0.7
NSD-425M	1.5~2.5	6.1	6.0	9.3	0.8	11.8	6,700	5.9	1,000	M4×0.7
NSD-435M	2.5~3.5	6.1	6.0	9.3	0.8	12.8	6,700	5.9	1,000	M4×0.7
NSD-5M	1.0~3.2	7.1	7.0	10.0	1.0	13.0	10,800	9.3	1,000	M5×0.8
NSD-515M	0.5~1.5	7.1	7.0	10.3	1.0	12.0	9,800	10.8	1,000	M5×0.8
NSD-525M	1.5~2.5	7.1	7.0	10.3	1.0	13.0	9,800	10.8	1,000	M5×0.8
NSD-535M	2.5~3.5	7.1	7.0	10.3	1.0	14.0	9,800	10.8	1,000	M5×0.8
NSD-6M	1.0~3.2	9.1	9.0	12.0	1.5	16.1	19,600	17.6	1,000	M6×1.0
NSD-625M	1.0~2.5	9.1	9.0	12.3	1.5	15.5	16,700	19.6	1,000	M6×1.0
NSD-640M	2.5~4.0	9.1	9.0	12.3	1.5	17.0	16,700	19.6	1,000	M6×1.0
NSD-8M	1.0~3.2	11.1	11.0	14.0	1.5	17.0	21,500	34.3	1,000	M8×1.25
NSD-825M	1.0~2.5	11.1	11.0	14.3	1.5	17.0	23,500	37.2	500	M8×1.25
NSD-840M	2.5~4.0	11.1	11.0	14.3	1.5	18.5	23,500	37.2	500	M8×1.25
NSD-1025M	1.0~2.5	13.1	13.0	16.3	1.5	17.5	29,400	58.8	500	M10×1.5
NSD-1040M	2.5~4.0	13.1	13.0	16.3	1.5	19.0	29,400	58.8	500	M10×1.5
NSD-1240M	2.5~4.0	16.1	16.0	19.0	1.5	20.0	40,200	97.2	300	M12×1.75

● **NAD/Aluminum (JIS A5056)**



● **Dimensions**

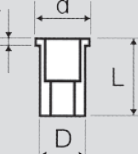

Model	Nut Setting Capacity	Hole diameter	Outer dimensions				Tensile N	Torque N · m	per package	Compatible screws
		mm	D(φmm)	d(φmm)	T(mm)	L(mm)				
NAD-4M	1.0~2.0	6.1	6.0	9.0	0.8	11.0	4,000	4.9	1,000	M4×0.7
NAD-415M	0.5~1.5	6.1	6.0	9.3	0.8	10.3	3,900	3.9	1,000	M4×0.7
NAD-425M	1.5~2.5	6.1	6.0	9.3	0.8	11.3	3,900	3.9	1,000	M4×0.7
NAD-435M	2.5~3.5	6.1	6.0	9.3	0.8	12.3	3,900	3.9	1,000	M4×0.7
NAD-5M	1.0~3.2	7.1	7.0	10.0	1.0	12.6	6,400	7.8	1,000	M5×0.8
NAD-515M	0.5~1.5	7.1	7.0	10.3	1.0	11.5	6,200	6.9	1,000	M5×0.8
NAD-525M	1.5~2.5	7.1	7.0	10.3	1.0	12.5	6,200	6.9	1,000	M5×0.8
NAD-535M	2.5~3.5	7.1	7.0	10.3	1.0	13.5	6,200	6.9	1,000	M5×0.8
NAD-6M	1.0~3.2	9.1	9.0	12.0	1.5	16.1	10,800	14.7	1,000	M6×1.0
NAD-625M	1.0~2.5	9.1	9.0	12.3	1.5	15.0	9,500	13.7	1,000	M6×1.0
NAD-640M	2.5~4.0	9.1	9.0	12.3	1.5	16.5	9,500	13.7	1,000	M6×1.0
NAD-8M	1.0~3.2	11.1	11.0	14.0	1.5	16.7	13,700	29.4	1,000	M8×1.25
NAD-825M	1.0~2.5	11.1	11.0	14.3	1.5	16.5	14,200	29.4	500	M8×1.25
NAD-840M	2.5~4.0	11.1	11.0	14.3	1.5	18.0	14,200	29.4	500	M8×1.25
NAD-1025M	1.0~2.5	13.1	13.0	16.3	1.5	17.0	19,100	37.2	500	M10×1.5
NAD-1040M	2.5~4.0	13.1	13.0	16.3	1.5	18.5	19,100	37.2	500	M10×1.5

Type K (Small flange)

● **NSK/Steel (JIS SWCH)**

※ made to order item



● **Dimensions**

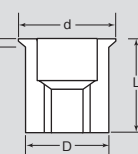

Model	Nut Setting Capacity	Hole diameter	Outer dimensions				Tensile N	Torque N · m	per package	Compatible screws
		mm	D(φmm)	d(φmm)	T(mm)	L(mm)				
NSK-3M	1.0~2.0	5.1	5.0	6.0	0.5	8.5	4,900	3.9	1,000	M3×0.5
NSK-4M	1.0~2.0	6.1	6.0	7.0	0.5	11.3	7,300	5.9	1,000	M4×0.7
NSK-415M	0.5~1.5	6.1	6.0	7.0	0.5	10.0	6,700	5.9	1,000	M4×0.7
NSK-425M	1.5~2.5	6.1	6.0	7.0	0.5	11.0	6,700	5.9	1,000	M4×0.7
NSK-435M	2.5~3.5	6.1	6.0	7.0	0.5	12.0	6,700	5.9	1,000	M4×0.7
NSK-5M	1.0~3.2	7.1	7.0	8.0	0.5	12.7	10,800	9.3	1,000	M5×0.8
NSK-515M	0.5~1.5	7.1	7.0	8.0	0.5	11.0	9,800	10.8	1,000	M5×0.8
NSK-525M	1.5~2.5	7.1	7.0	8.0	0.5	12.0	9,800	10.8	1,000	M5×0.8
NSK-535M	2.5~3.5	7.1	7.0	8.0	0.5	13.0	9,800	10.8	1,000	M5×0.8
NSK-6M	1.0~3.2	9.1	9.0	10.0	0.8	15.4	19,600	17.6	1,000	M6×1.0
NSK-625M	1.0~2.5	9.1	9.0	10.0	0.5	14.0	16,700	19.6	1,000	M6×1.0
NSK-640M	2.5~4.0	9.1	9.0	10.0	0.5	15.5	16,700	19.6	1,000	M6×1.0
NSK-8M	1.0~3.2	11.1	11.0	12.0	0.8	16.5	21,500	34.3	1,000	M8×1.25
NSK-825M	1.0~2.5	11.1	11.0	12.0	0.5	15.5	23,500	37.2	500	M8×1.25
NSK-840M	2.5~4.0	11.1	11.0	12.0	0.5	17.0	23,500	37.2	500	M8×1.25
NSK-10M	1.0~4.0	13.1	13.0	14.0	0.8	17.8	24,500	44.1	500	M10×1.5
NSK-1025M	1.0~2.5	13.1	13.0	14.0	0.5	16.0	29,400	58.8	500	M10×1.5
NSK-1040M	2.5~4.0	13.1	13.0	14.0	0.5	17.5	29,400	58.8	500	M10×1.5
NSK-1240M	2.5~4.0	16.1	16.0	18.0	0.7	20.8	40,200	97.2	300	M12×1.75

Rivet Nuts

Type K (Small flange)

● **NAK/Aluminum (JIS A5056)**



● **Dimensions**

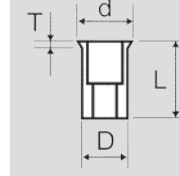

Model	Nut Setting Capacity	Hole diameter	Outer dimensions				Tensile N	Torque N · m	per package	Compatible screws
		mm	D(φmm)	d(φmm)	T(mm)	L(mm)				
NAK-4M	1.0~2.0	6.1	6.0	7.0	0.5	11.3	4,000	4.9	1,000	M4×0.7
NAK-415M	0.5~1.5	6.1	6.0	7.0	0.5	10.0	3,900	3.9	1,000	M4×0.7
NAK-425M	1.5~2.5	6.1	6.0	7.0	0.5	11.0	3,900	3.9	1,000	M4×0.7
NAK-435M	2.5~3.5	6.1	6.0	7.0	0.5	12.0	3,900	3.9	1,000	M4×0.7
NAK-5M	1.0~3.2	7.1	7.0	8.0	0.5	12.7	6,400	7.8	1,000	M5×0.8
NAK-515M	0.5~1.5	7.1	7.0	8.0	0.5	11.0	6,200	6.9	1,000	M5×0.8
NAK-525M	1.5~2.5	7.1	7.0	8.0	0.5	12.0	6,200	6.9	1,000	M5×0.8
NAK-535M	2.5~3.5	7.1	7.0	8.0	0.5	13.0	6,200	6.9	1,000	M5×0.8
NAK-6M	1.0~3.2	9.1	9.0	10.0	0.5	14.6	10,800	14.7	1,000	M6×1.0
NAK-625M	1.0~2.5	9.1	9.0	10.0	0.5	14.0	9,500	13.7	1,000	M6×1.0
NAK-640M	2.5~4.0	9.1	9.0	10.0	0.5	15.5	9,500	13.7	1,000	M6×1.0
NAK-8M	1.0~3.2	11.1	11.0	12.0	0.5	15.7	13,700	29.4	1,000	M8×1.25
NAK-825M	1.0~2.5	11.1	11.0	12.0	0.5	15.5	14,200	29.4	500	M8×1.25
NAK-840M	2.5~4.0	11.1	11.0	12.0	0.5	17.0	14,200	29.4	500	M8×1.25
NAK-1025M	1.0~2.5	13.1	13.0	14.0	0.5	16.0	19,100	37.2	500	M10×1.5
NAK-1040M	2.5~4.0	13.1	13.0	14.0	0.5	17.5	19,100	37.2	500	M10×1.5

● **NTK/Stainless (JIS SUS303)**



● **Dimensions**

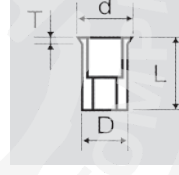

Model	Nut Setting Capacity	Hole diameter	Outer dimensions				Tensile N	Torque N · m	per package	Compatible screws
		mm	D(φmm)	d(φmm)	T(mm)	L(mm)				
NTK-3M15	0.5~1.5	5.1	5.0	6.0	0.7	8.7	8,900	2.9	200	M3×0.5
NTK-4M	0.3~1.0	6.1	6.0	7.0	0.7	9.5	9,800	6.8	200	M4×0.7
NTK-4M20	1.0~2.0	6.1	6.0	7.0	0.7	10.6	9,800	6.8	200	M4×0.7
NTK-4M25	1.5~2.5	6.1	6.0	7.0	0.7	11.2	9,800	6.8	200	M4×0.7
NTK-4M35	2.5~3.5	6.1	6.0	7.0	0.5	12.0	9,800	6.8	200	M4×0.7
NTK-5M	0.3~1.5	7.1	7.0	8.0	0.7	11.1	11,800	9.8	200	M5×0.8
NTK-5M30	1.5~3.0	7.1	7.0	8.0	0.7	12.1	11,800	9.8	200	M5×0.8
NTK-6M	0.3~2.0	9.1	9.0	10.0	0.7	14.1	22,500	21.5	100	M6×1.0
NTK-6M40	2.0~4.0	9.1	9.0	10.0	0.7	15.6	22,500	21.5	100	M6×1.0
NTK-8M	0.3~2.0	11.1	11.0	12.0	0.7	15.0	27,500	44.1	100	M8×1.25
NTK-8M40	2.5~4.0	11.1	11.0	12.0	0.7	17.2	27,500	44.1	100	M8×1.25
NTK-10M	0.3~2.0	13.1	13.0	14.0	0.7	15.7	29,400	49.0	100	M10×1.5
NTK-10M40	2.5~4.0	13.1	13.0	14.0	0.7	17.7	29,400	49.0	100	M10×1.5

LOBSTER Serrated Rivet Nuts

- ▶ Tapered tip means ease-of-insert into holes, making rivet nuts suitable for use with auto riveting.
- ▶ The serrations on the shaft ensure snug fit into the base material and virtually eliminate loosening.

NSK·NSD series

Soft clamping makes the rivet nut perfect for use with thin or soft boards. 30% less clamping strength than standard rivets enables more delicate fastening.



NSK-□MR (Small flange) NSD-□MR (Large flange)

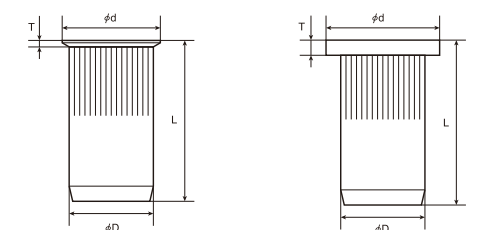

	Model	Nut Setting Capacity	Hole diameter	Outer dimensions			Tensile N	Torque N · m	per package	Compatible screws	
			mm	D(φmm)	d(φmm)	T(mm)					L(mm)
K type (Small flange)	NSK-4MR	0.5~2.0	6.1	6	7	0.5	10.0	5,400	5.9	1,000	M4×0.7
	NSK-5MR	0.5~3.2	7.1	7	8	0.5	12.0	8,500	9.3	1,000	M5×0.8
	NSK-6MR	0.5~3.2	9.1	9	10	0.6	15.0	14,100	17.6	1,000	M6×1.0
	NSK-8MR										

ST Lock

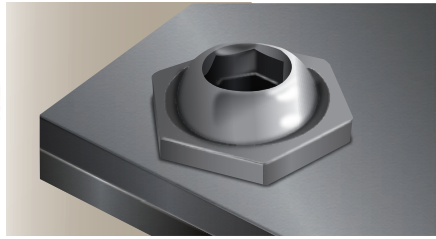

What is "LOBSTER" ST Lock ?

- ⦿ One-sided operation
- ⦿ Excellent vibration-resistance mechanism
- ⦿ High fastening power
- ⦿ Zero marring or scratching of material surfaces
- ⦿ Eco-Friendly finish
- ⦿ Beautiful and massive appearance
- ⦿ Various applications

Typical Applications

- Steel frame housing beam joints
- Steel frame stairways
- Curtain walls
- Switchboard cabinets
- Sirocco fans
- Distribution equipments truss joints
- Products for highway facilities
- Hinge joints
- Transport equipments (truck, automotive, etc)

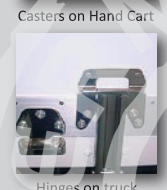

"LOBSTER" ST Lock makes your work easy and overwhelmingly speedy by one-side action high-tensile fastening.

By switching from standard Bolt/Nut joint or Welding to "LOBSTER" ST Lock one-side action high-tensile fastening, significant cost reduction and work efficiency even for beginners are realized!

For a closed space beyond your reach, where standard Bolt/ Nut joint can not work well.

For workpieces which require high-strength fastening, which can not be achieved by blind rivets.

One-sided operation, high-strength fastening !

Quick and tight structural Lock with a simple tool (Cargo Nutrunner or Attachment ST Lock Nut Runner), special technique like welding is not required.



from welding to "Lobster" ST Lock

from joint by bolt/nut to "Lobster" ST Lock

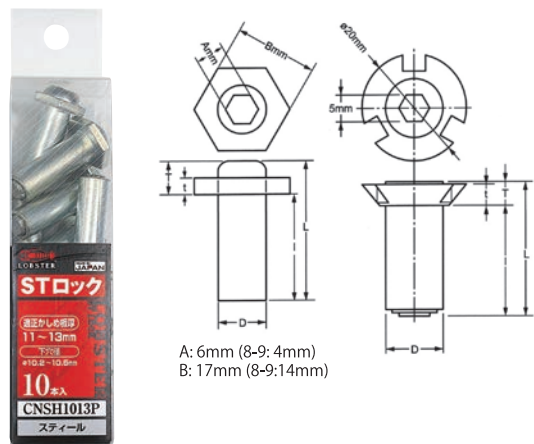

Work procedure

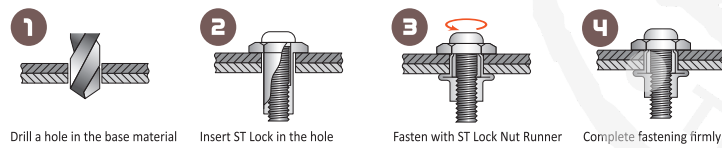

Model	Appropriate material thickness mm	Hole diameter ϕ mm	Dimensions					Strength		per package
			D ϕ mm	L ϕ mm	I ϕ mm	T ϕ mm	t ϕ mm	Tensile kN	Shearing kN	
CNSH109P	7~9	10.2~10.5	10	31	24.0	6.5	3	16.5	27.5	12
CNSH1013P	11~13			36	28.0					10
CNSH1016P	14~16			37.5	31.0					8

Attachment ST Lock Nutrunner



● Allows to set LOBSTER Φ 10 Steel ST Lock quickly converting your cordless impact driver(14.4V) into ST Lock Nut runner.

Model	Length mm	Shank diameter mm	ST lock size	Weight g
@RS-10i	190	6.35	Φ 10 steel plated	450

* Do not use the ST Lock other than Φ 10mm steel or special surface treated material.
* Impact drivers is not sold together with this tool.



Technical Data

Air Coupler Selection Table

Model	Air insert type
All models	G1/4 (PF1/4) male screw

Basic Compressor Selection Table

1. Unit without vacuum

Selection of the appropriate compressor will differ depending upon the number of times riveting is to take place (the number of times the trigger is to be pulled). Based on 10-rivets/minute operation, the number of riveters that can be used at one time with the corresponding compressor is listed in the following table. (At only 5-rivets/minute, twice the number of riveters indicated may be used.)

Compressor output kW(PS)	Number of riveters that can be used at one time for 10-rivets/minute operation.					
	AR-2000S AR-011S	AR-011M AR-011P	AR-2000M	AR-011H AR-021H	AR-2000H	AR-022M AR-021EX
0.2kW (1/4PS)	4	1	1	0	0	0
0.4kW (1/2PS)	8	3	2	1	1	1
0.75kW (1PS)	16	6	5	3	2	2
1.5kW (2PS)	33	13	11	6	5	4
2.2kW (3PS)	50	20	17	10	8	6
3.7kW (5PS)	83	33	29	17	13	10

*Note: Air pressure: 0.6 MPa (6 kgf/cm2)

2. Unit with vacuum

Regardless of the number of rivets per minute, refer to the following table when selecting compressor.

Compressor output kW(PS)	ARV-015S	R1A1 AR-2000SV·AR-2000MV ARV-015M·ARV-011M	ARV-025M VU-S VU-M	R1A2 ARV-022M·AR-2000HV VU-H48·VU-H64
0.75kW (1PS)	1	1	0	0
1.5kW (2PS)	3	2	1	1
2.2kW (3PS)	5	3	2	2
3.7kW (5PS)	8	5	4	3

*Note: Air pressure: 0.6 MPa (6 kgf/cm2)

3. Air Conditioning

Set up the compressor, and be sure to install an air filter, air regulator, and air lubricator (3-device set) between the compressor and the tool.

Adjust the drip-feed amount of the air lubricator to the minimum setting.

ATTENTION

In the case of usage in cold district/locations, the moisture contented air in the tool body may be frozen on the inside cylinder surface. As a result, it may not work.

To dehydrate, we recommend to add an air-dryer unit to the normal three units (Regulator, Filter, and Lubricator).

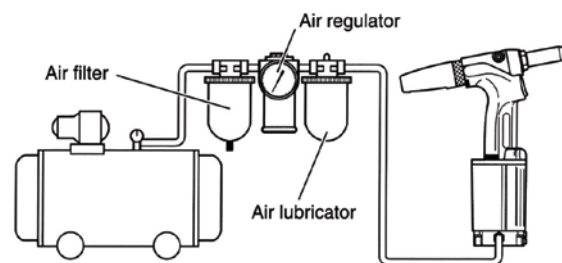

4. Operating Air Pressure

Use the air regulator to adjust the operating air pressure to the instruction manual.

ATTENTION

If the air pressure is too high, damage to parts may occur. If the pressure is too low, certain size rivet may not be correctly installed (cut).

Special used for blind rivets

For riveting problematic locations

Fastening rivets next to wall

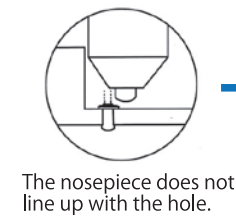
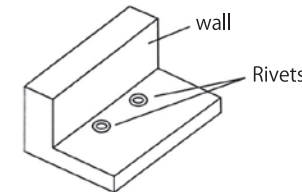

Using a long nosepiece

Cutting the frame head

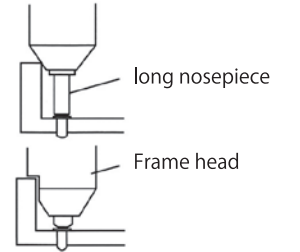

Fastening rivets in groove

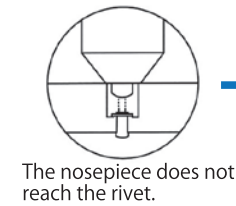
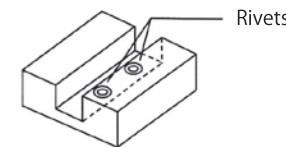

Using a long nosepiece

Cutting the frame head

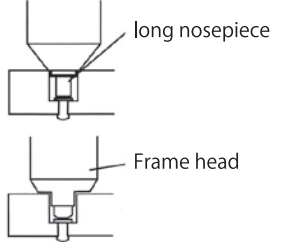

Fastening rivets in deep settings

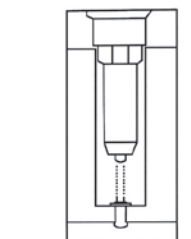
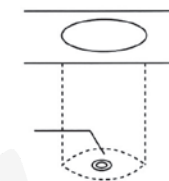

Using a long frame head

When Using a long frame head, it is necessary to use long parts within the frame head as well.

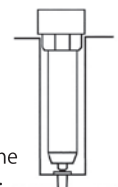

Using a long nosepiece

Mandrel length for long nosepieces

When using a long nosepiece, first verify the length of the mandrel (indicated as S in the diagram below) and then use a rivet with a mandrel that is longer than that indicated under "Required mandrel length" in the following table (in order to secure sufficient jaw bite).

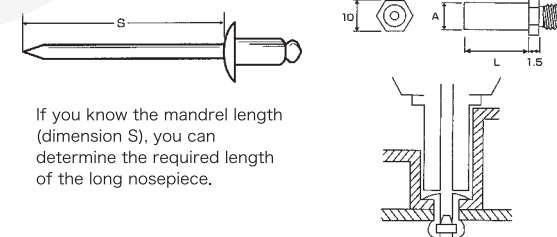

Standard long nosepiece

Rivet size	Part number	Length: L	Tip diameter: A	Required mandrel length: S (mm)	
				Riveter S. M	Riveter H. EX
3.2	LN32-10	10	6.5	30	31
	LN32-15	15		35	36
	LN32-20	20		40	41
4.0	LN40-10	10	7.0	31	32
	LN40-15	15		36	37
	LN40-20	20		41	42
4.8	LN48-10	10	7.5	33	33
	LN48-15	15		38	38
	LN48-20	20		43	43

* Note: Long nosepieces other than those listed above are available upon consultation. (Production upon order)

Using a long frame head



Long frame head set

Parts NO.	Added length (mm)	Total length (mm)	Compatible models
LFH011+85	85	143	AR011MX, ARV015MX, ARV025M*1
LFH011+95	95	153	
LFH011+142	142	200	
LFH041+30	30	88	AR2000M, AR2000MV*1
LFH041+70	70	128	
LFH041+85	85	143	
LFH041+100	100	158	
LFH041+150	150	208	

Long frame head set consists of a long frame head and a jaw case adapter.
※1 Models with vacuum system need long guide pipe separately.

Technical Data

Galvanic corrosion

When different metals come in contact and are in an electrically conductive fluid, the metal of lower voltage acts like the anode + (plus) and the higher voltage metal as the cathode - (minus) of a battery, and they constitute a "corrosion cell", with the plus side metal becoming ionized and dissolving (corroded). This type of corrosion is referred to as galvanic corrosion or electrochemical corrosion.

Conditions conducive to galvanic corrosion (general environment)

- 1) Large difference in voltage
- 2) High temperatures and humidity, high acidity
- 3) The + side metal has small surface area
- 4) Salt particles exist in the atmosphere

Acceptable metal combinations

There are limits to acceptable combinations of metal as indicated in the table on page 16 of the MIL-STD-171A standard. Normally, it is desirable for different metals to have less than a 0.1 V difference.

(Corrosion generated during contact between different metals)

Examples of galvanic corrosion in rivet joints

(1) Aluminum rivet and stainless steel material

The aluminum rivet will corrode considerably at the point of contact with the stainless steel material. This is an extremely inappropriate application.

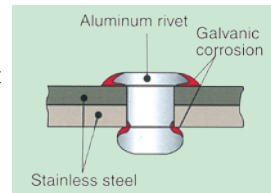

(2) Stainless steel rivet and aluminum material

The aluminum material will corrode at the point of contact with the stainless steel rivet. If, however, the surface area of that material is large, progress of the corrosion will be relatively slow, so this application may be acceptable depending upon environmental conditions.

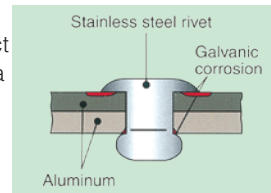

(3) Aluminum rivet and zinc-plated steel material

The zinc plating on the steel material will corrode at the point of contact with the aluminum rivet, and corrosion will then advance on the aluminum rivet. This is a relatively poor application, but may still be applicable for long-term use depending upon environmental conditions.

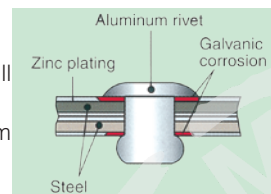

(4) Zinc-plated steel rivet and aluminum material

The zinc plating on the steel rivet will corrode at the point of contact with the base material, and corrosion will then advance on the aluminum material. However, that advance will be extremely minimal, so this application may be acceptable depending upon environmental conditions.

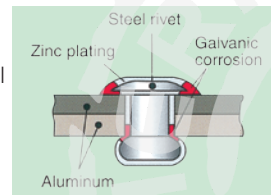

- The example combinations above apply to joining parts in outside installations, external parts on automobiles, boats, etc.
 - In the case of general interiors or electric appliances, even these example combinations may be adequate.
- Contact our company representative or technical support if you have any technical questions.

Measures against galvanic corrosion

- Select rivet of the same voltage or only slight difference in voltage from the base material.
- Coat (plating, etc.) the rivet or material with a metal that has the same or only slight difference in voltage from the remaining component.
- Insulate the rivets and base material overall with some type of coating (paint, etc.).
- Employ resin or other material as insulation between the metals (coating, push, etc.).
- Employ some other metal that possesses voltage between that of the two materials to act as insulation between those materials (plating, coating, push, etc.).
- Make sure the rivet has a higher voltage than the base material.

Acceptable metal combinations (as per MIL-STD-171A)

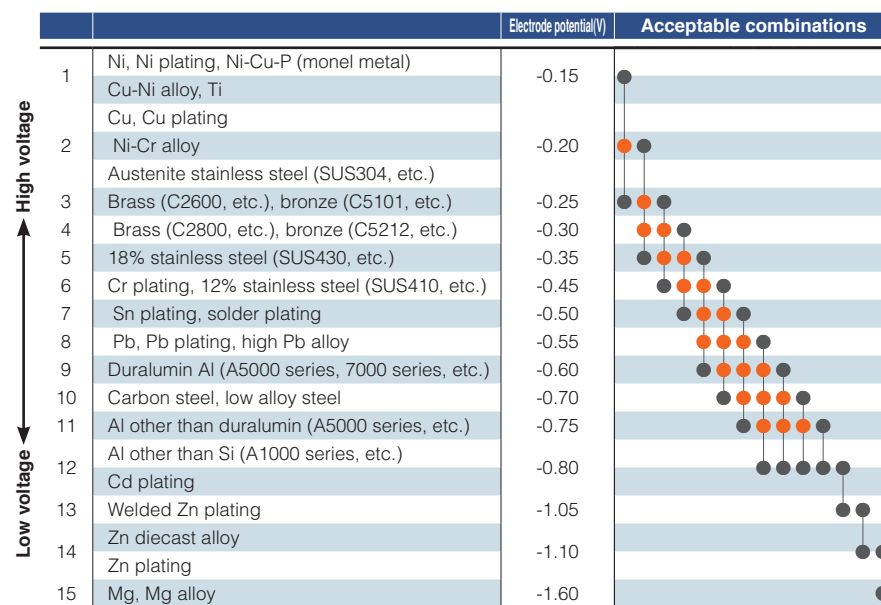

● : Negative charge ● : Positive charge - Metals connected by a line indicate acceptable combinations



